

Translation of the paper
**Connaissance actuelle des orbites
dans le problème des trois corps**
or “Current knowledge of orbits in the
three body problem”
by Ellis Strömngren

Translated by: Maxime Murray

and J.D. Mireles James

May 2018

Abstract

This work is a translation from French of the memoir “Connaissance actuelle des orbites dans le problème des trois corps” written by Elis Strömngren in 1933 about his research at the Copenhagen observatory. This work is often referred to in contemporary works however it appears to be only available in French. This is a modest attempt by the authors to make this paper more accessible, which we have attempted primarily for our own illumination. Any discrepancies between the original and this translation are personal translation choice or omission by us.

1 Introduction

In his famous essay “Essai sur le problème des trois corps” of 1772, Lagrange solved exactly some special cases of the three body problem. These special cases correspond to periodic motions of the three bodies: that is, a motion where all three masses return to the same mutual position after an equal interval of time. Lagrange himself remarked that, although he did not believe that his special cases could appear in nature, they nevertheless deserve our attention. Indeed he hoped that they could illuminate the general solution to the three body problem.

Since Lagrange's era we have actually discovered in our own solar system a case corresponding approximatively to one of Lagrange's special case. This group of small asteroids is referred to as Jupiter's group. Still, Lagrange's intuition regarding the theoretical importance of those solutions has proven to be completely correct; these solutions were indeed the starting point for crucial progress in our understanding of the movements of the general three body problem, from Lagrange up to this day. The idea of how to generalize those particular solutions is again attributed to Lagrange, as he suggested in his essay to investigate how the three bodies would move if they were positioned near – but not exactly at – one of those special cases. In this case one might solve the equations of motion using some well known analytic approximation methods. A hundred years past before some researchers succeeded in following that idea (Gascheau, Routh, Gylden and others). While this represented a huge step forward, it is still just the beginning. The approximation obtained is only as good as the small difference between Lagrange's exact solutions and the perturbation.

It is the numerical integration methods which have proved the best fit for solving the differential equations associated with the three body problem. This method, more than any other, has improved our knowledge of the problem. The technique consists of numerically computing the motion, step-by-step, by computing, step-by-step as well, the forces acting on the body. If one choose carefully the time step for the integration, it is possible to obtain the result up to the desired accuracy. In some extraordinary cases, for example when two masses get really close to each other and forces become abnormally big, it is necessary to make a convenient change of coordinates. After such a change it becomes possible to follow numerically to the extreme case where the bodies collide, giving rise to a force whose strength grows to infinity.

The approach of numerical integration has played a big role in astronomy for some time. It was used to find trajectories for hundreds of small planets and comets in our solar system, and in these cases the approximations match exactly the observations. But it is only at the end of the past century, in the work of T.N. Thiele, where numerical integration entered the general theory of the problem of three bodies.

2 The problem

The wide majority of the work conducted at Copenhagen observatory considers the following problem:

Two equal masses m_1 and m_2 are governed by the equations of motion for the two body problem. Initial conditions are fixed so that these two masses follow, with constant speed, a circular mo-

tion around their center of mass.

We then study the motion of an infinitely small third mass μ moving in the field of the two finite masses. The problem is visualized as in figure 1 at the bottom of Table 1. The massless particle μ does not itself effect the motion of m_1 and m_2 , who continue to evolve along their circular path. We refer to this problem as the generalized restricted problem. This problem is different from Poincaré's, since we do not assume that one of the finite masses is small in comparison to the other one. We recall that under this assumption the problem is simplified, since it is then seen as a perturbation of the Kepler problem. We can solve such case using the analytical methods alluded to above, as one would for the problem of the planet's motion in our solar system.

In our research at Copenhagen observatory the finite masses have a similar size. The numerical techniques we apply need the choice of a specific mass ratio and, as just mentioned, we chose to fix $m_1 = m_2$ to assure a distinction from the relatively simple perturbation problem. We use numerical integration to study the resulting differential equations. For each orbit we consider, we must specify a mass ratio as well as initial conditions for the particle μ . Ideally the research then consists of evolving this initial state until we reach a complete and in depth understanding of the motion of the particle in both forward and backward time.

In his late 19th century work *Méthodes nouvelles de la Mécanique céleste*, Poincaré studied the three body problem using an analytical rather than numerical point of view. Among his results he showed the existence of two particular groups of solutions; purely periodic solutions and asymptotically periodic ones. (*Translator's note: "asymptotic orbit" or "asymptotic periodic orbit" is the old fashioned term used by dynamical astronomers for what we today call a heteroclinic or homoclinic connecting orbit*). The results of Poincaré did not always have perfect clarity, however they showed their value to this domain. They gave a concrete object of study for Poincaré's abstract propositions, and they showed the existence of periodic and asymptotic solutions under general conditions for certain mass ratios.

Our work started at the end of the last century, first inspired by the work of Thiele and later by the treatise "Periodic Orbits" by G.H. Darwin. Darwin chose a different "Jove-like" mass ratio, $m_1 = 10m_2$: that is he took one of the masses smaller than the other. For the work conducted in Copenhagen we always chose instead the same masses as Thiele, unless special circumstances required otherwise. The systematic search for simple orbits, periodic or asymptotic, started in 1913 in Copenhagen observatory and is by now considered essentially complete. For the historical development of the approach we refer to the bibliography, especially

[37, 38, 40, 47]. In every case we adopt co-rotating coordinates which fix the location of m_1 and m_2 on the x -axis. This rotating frame is used for all the figures in this work. The starting point for all our research is briefly described in the following remarks.

A. For the infinitesimal mass μ there exist infinitely many small periodic orbits about both primaries. Figure 1 in Table 1 gives a representation of the problem. The arrows show the direction of the rotation of the finite masses around their center of gravity. We say that an orbit is *direct* if it moves in the counterclockwise direction, and *retrograde* the opposite direction. There exist both direct and retrograde periodic orbits around the two primaries.

B. There exist direct and retrograde orbits which encircle both masses.

C. As already shown by Lagrange, there exists five relative equilibrium points in the rotating frame, namely the libration points \mathcal{L}_1 , \mathcal{L}_2 , \mathcal{L}_3 , \mathcal{L}_4 , \mathcal{L}_5 (see figure 1 in Table 1). The libration points have the property that a mass μ placed at any of those points with zero velocity will remain forever at the point of libration. In other words, μ will remain motionless. In the Copenhagen problem ($m_1 = m_2$) \mathcal{L}_1 is between m_1 and m_2 , \mathcal{L}_2 and \mathcal{L}_3 are respectively to the right of m_2 and to the left of m_1 , while \mathcal{L}_4 and \mathcal{L}_5 are the vertices of the equilateral triangles formed by m_1 , m_2 and a third point.

In this work we refer to *classes of orbits*. We briefly describe our numerical procedure for locating periodic orbits. We consider μ initially located on the η axis with some initial velocity perpendicular to the axis. We follow the trajectory using numerical integration until it reaches the ξ axis. Suppose we find, for example, that it crosses this axis with an angle near 90 degrees. Then we begin again with the same initial position but with a slightly different initial velocity. Imagine that we find now, for example, that the orbit crosses the ξ axis with yet another angle slightly different from 90 degrees, still different from the first one found (see figure 1). Using interpolation and repeated experience we locate an orbit with the same initial position on the η axis and an initial velocity causing the orbit to intersect the ξ axis with an angle of 90 degrees. It follows from the symmetry (see equation (3)) of the differential equations that the trajectory in the first quadrant determines the trajectory in the other quadrants by rotation. That is, the mass will cross the η axis again with a 90 degree angle at a point whose coordinate is equal to the initial point. Then the orbit in the 3rd and 4th quadrant is a reflection of the first half, and the orbit of μ will cut the η axis exactly at the initial point and with the initial velocity.

In other words, we obtain a periodic orbit: that is a finite orbit segment whose shape determines the behavior of μ for all time. If one repeats the experiment with a different starting point on the η axis, but near the first one, we can generally find a new velocity

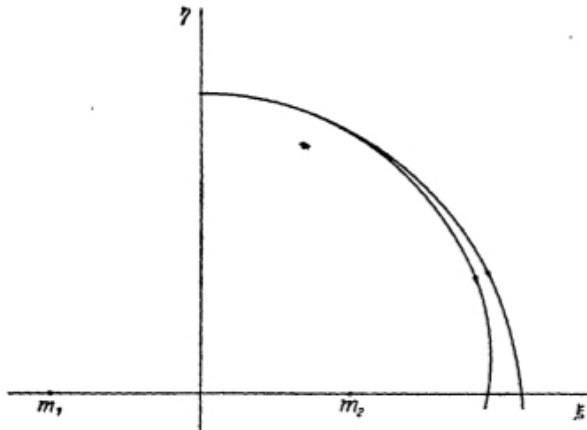

Fig. 1.

such that this trajectory is periodic as well. The new trajectory is not much changed from the initial one. Repeating the procedure, we find a whole cylinder of periodic orbits which can be continued from one to another. We say that they belong to the same *class* of orbits. We remark, as we will see later, some periodic motions that are not symmetric with respect to both axis. The way to find such periodic orbits is a modification of the procedure just discussed.

The research in Copenhagen discovered several different classes of orbits. We express some of the cases as follows. For all the simple periodic orbits, that is those completed with only one revolution, we continue the class and realize that either:

1. The class enters itself; (the cylinder closes off forming a torus).
2. The class has terminates on a collision orbit or an asymptotic orbit. More precisely the cylinder may end at
 - (a) A collision orbit involving one or both of the primaries;
 - (b) An orbit asymptotic to one (or two) of the five libration points;
 - (c) An orbit which diverges to infinity.

We illustrate examples of each of those behaviors. Indeed, we have

- Type 1. in the classes of orbits **I, II, XIV,**
- Type 2.(a) in the classes of orbits **VIII, X, XI, XII, XIII,**
- Type 2.(b) in the classes of orbits **III, VI, VII, IX, XV, XVI, XVII, XVIII,**
- Type 2.(c) in the classes of orbits **III, VI, VIII, X, XI.**

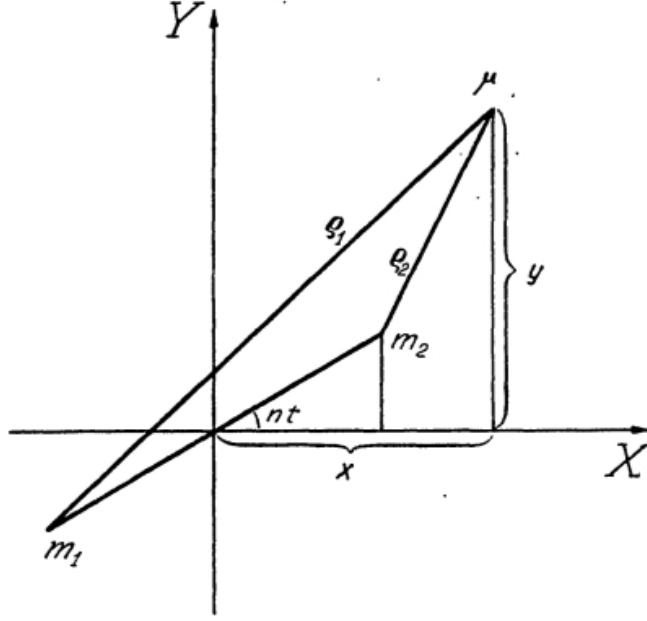

Fig. 2.

3 Equation of motion in the restricted problem

To choose the system of coordinates recall that we first fix center of mass at the origin and set n to be the angular velocity of the primaries. Following the notation from figure 2, we obtain the following equations of motion for the massless particle μ :

$$\begin{cases} \ddot{x} = -k^2 m_1 \frac{x+a \cos(nt)}{\rho_1^3} - k^2 m_2 \frac{x-a \cos(nt)}{\rho_2^3}, \\ \ddot{y} = -k^2 m_1 \frac{y+a \sin(nt)}{\rho_1^3} - k^2 m_2 \frac{y-a \sin(nt)}{\rho_2^3}, \\ \rho_1^2 = (x + a \cos(nt))^2 + (y + a \sin(nt))^2, \\ \rho_2^2 = (x - a \cos(nt))^2 + (y - a \sin(nt))^2, \end{cases} \quad (1)$$

where k is the gravitational constant and a is half the distance between m_1 and m_2 . We choose the unit for length and time as follow; set $a = 1$ (thus the distance between m_1 and m_2 is 2) and $n = 1$. Now, since

$$n = k \frac{\sqrt{m_1 + m_2}}{(2a)^{\frac{3}{2}}}$$

we have that

$$1 = k \frac{\sqrt{m_1}}{2} = k \frac{\sqrt{m_2}}{2},$$

thus

$$k^2 m_1 = k^2 m_2 = 4.$$

Therefore the equations of motion become

$$\begin{cases} \ddot{x} = -4 \left(\frac{x+\cos(t)}{\rho_1^3} + \frac{x-\cos(t)}{\rho_2^3} \right), \\ \ddot{y} = -4 \left(\frac{y+\sin(t)}{\rho_1^3} + \frac{y-\sin(t)}{\rho_2^3} \right), \\ \rho_1^2 = (x + \cos(t))^2 + (y + \sin(t))^2, \\ \rho_2^2 = (x - \cos(t))^2 + (y - \sin(t))^2. \end{cases} \quad (2)$$

In the rotating set of coordinates just described, let the coordinates of μ be given by ξ and η so that

$$\begin{aligned} x &= \xi \cos t - \eta \sin t, \\ y &= \xi \sin t + \eta \cos t. \end{aligned}$$

After application of this substitution in (2), we obtain

$$\begin{cases} \ddot{\xi} - 2\dot{\eta} - \xi = -4 \left(\frac{\xi+1}{\rho_1^3} + \frac{\xi-1}{\rho_2^3} \right), \\ \ddot{\eta} + 2\dot{\xi} - \eta = -4 \left(\frac{\eta}{\rho_1^3} + \frac{\eta}{\rho_2^3} \right), \\ \rho_1^2 = (\xi + 1)^2 + \eta^2, \\ \rho_2^2 = (\xi - 1)^2 + \eta^2, \end{cases} \quad (3)$$

which can be shorten to

$$\begin{cases} \ddot{\xi} - 2\dot{\eta} = \frac{\partial U}{\partial \xi}, \\ \ddot{\eta} + 2\dot{\xi} = \frac{\partial U}{\partial \eta}, \end{cases} \quad (4)$$

where U is defined as

$$U = \frac{1}{2}(\xi^2 + \eta^2) + 4 \left(\frac{1}{\rho_1} + \frac{1}{\rho_2} \right). \quad (5)$$

From (4), we deduce the Jacobi integral

$$\dot{\xi}^2 + \dot{\eta}^2 = \xi^2 + \eta^2 + 8 \left(\frac{1}{\rho_1} + \frac{1}{\rho_2} \right) - K, \quad (6)$$

where K is called the Jacobi constant.

Numerical integration of the system (3) is not difficult as long as the mass μ does not approach any of the primaries. We now recall the mathematical transformation making it possible to follow the motion of the massless particle when μ passes close to a primary or the case with infinite velocity. At the Copenhagen observatory we utilize the transformation as Thiele suggested. Instead of ξ, η, t we introduce E, F as coordinates and ψ to represent time. The coordinates are related by the transformation

$$\begin{cases} \xi = \frac{e^F + e^{-F}}{2} \cos E, \\ \eta = -\frac{e^F - e^{-F}}{2} \sin E, \\ dt = \rho_1 \rho_2 d\psi. \end{cases} \quad (7)$$

After substitution of those expressions in (3), we obtain the system

$$\begin{cases} \frac{d^2 E}{d\psi^2} = (\cos(2iF) - \cos(2E)) \frac{dF}{d\psi} + \frac{1}{4} \sin(4E) - \frac{K}{2} \sin(2E), \\ \frac{d^2 F}{d\psi^2} = -(\cos(2iF) - \cos(2E)) \frac{dE}{d\psi} + \frac{1}{4i} \sin(4iF) - \frac{K}{2i} \sin(2iF) + \frac{8}{i} \sin(iF). \end{cases} \quad (8)$$

These transformed equations are well suited for numerical integration, especially in the case where the system (3) fails for the reason previously mentioned. A table for the approximative computation of E, F by ξ, η (or reversely) is given in [4] and in [15].

4 The results

The works [11, 37, 38, 40] contain other summaries of the result of the research at the Copenhagen observatory in the years 1917, 1922, 1923 and 1925. Table 1 comes from the 1925 paper and was originally made by request from the Deutsches Museum in Munich. The majority of what we currently know about the importance of asymptotic orbits (especially in Table 6 and 7) came after 1925. The present work gives a general presentation of our research up to this day. The ordering of the problems in this presentation is chosen for historical and systematic reasons. To save room we changed the scale of some drawings resulting in uneven format. The naming from previous works is sometimes included in parenthesis after the name of the different classes.

I. Retrograde periodic orbits (Librations) around \mathcal{L}_2 (Class a).

This is the first problem solved by numerical integration and it gave rise to one class of periodic orbits. The problem was stated by Thiele and then solved by himself and M. Burrau [1, 2, 50].

In figure 3 we see the two finite masses m_1 and m_2 ; the ξ axis is the line passing through m_1 and m_2 ; the η axis passes through the center of gravity (that is the middle of the segment $m_1 m_2$ as $m_1 = m_2$). The libration point \mathcal{L}_2 is located at the middle of the small ellipse representing the periodic movement (a member of the \mathcal{L}_2 Lyapunov family of periodic orbits), which was found using theoretical research. The first periodic orbit drawn outside the ellipse was computed by Thiele using numerical integration, and the next one by Burrau. If the motion of m_1 and m_2 correspond to the arrows in figure 1 of Table 1 (direct motion), the periodic orbits of μ around \mathcal{L}_2 has retrograde motion (see the arrows in figure 3). We call the motion of μ retrograde.

The work of Thiele and Burrau contained much more than just the numerical demonstration that periodic orbits around \mathcal{L}_2 exist. They also investigate how those orbits evolve as they get further

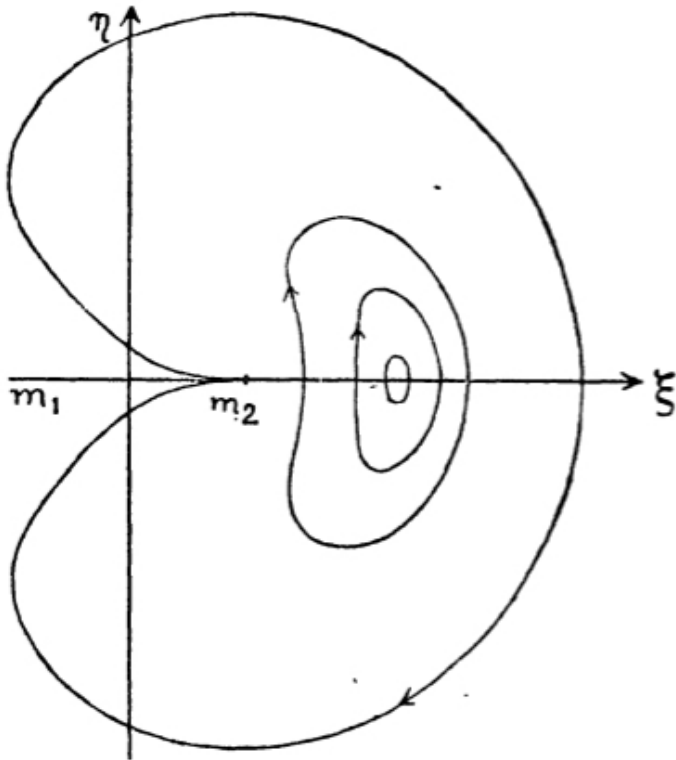

Fig. 3.

from the libration point. Burrau showed that the periodic orbits terminate in a *periodic collision orbit* (see figure 3); the infinitesimal mass comes from below, turns to the right into m_2 with a velocity increasing to infinity, then turns around and goes left with infinite velocity at first who then decreases to finite, then μ moves up and later to the right to finally come back to the initial point.

Burrau stopped at the collision. However there is no reason not to follow the class beyond this. When the work on the classes of simple periodic orbits started in 1913, this class was brought back to attention. The results are found in figure 4.

Following the development starting from the collision, one obtains orbits which loop around m_2 (bottom left in figure 4). The loop keeps increasing (top right) while the outside trajectory gets smaller. This behavior continues until the loop and the trajectory completely overlap. And, if we continue, the small loop becomes the big while the big becomes the small. That is, we find the same development but in reverse. We then enter back into the collision at m_2 and then finish where we started, at the libration point \mathcal{L}_2 . So the class of orbits returns to itself (as in case 1. in the general proposition).

The collision orbit, as well as other orbits nearby, were indeed computed using Thiele's E and F coordinates. Figure 5 shows the

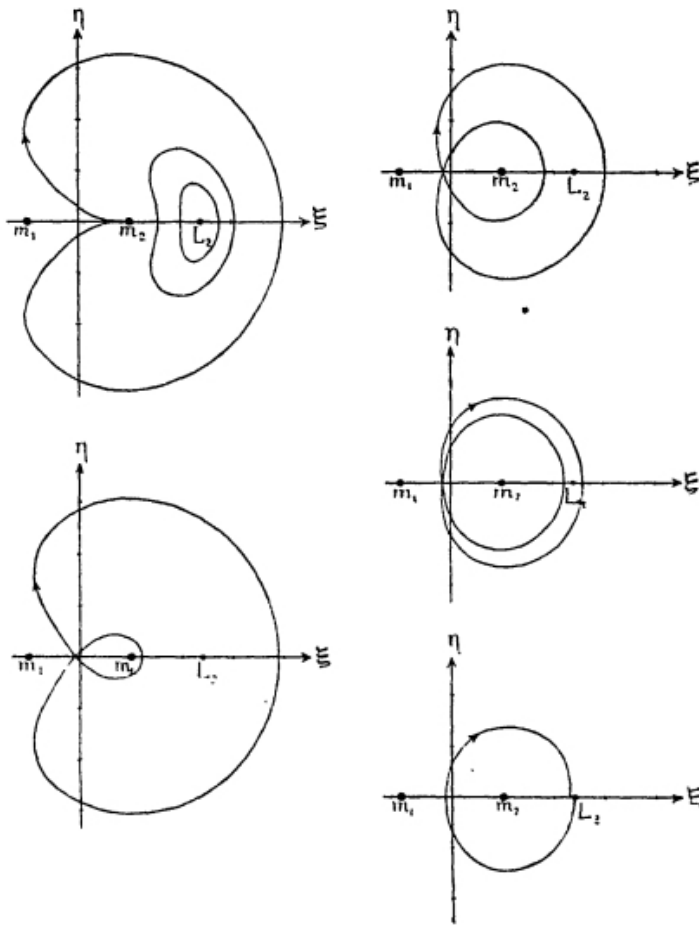

Fig. 4.

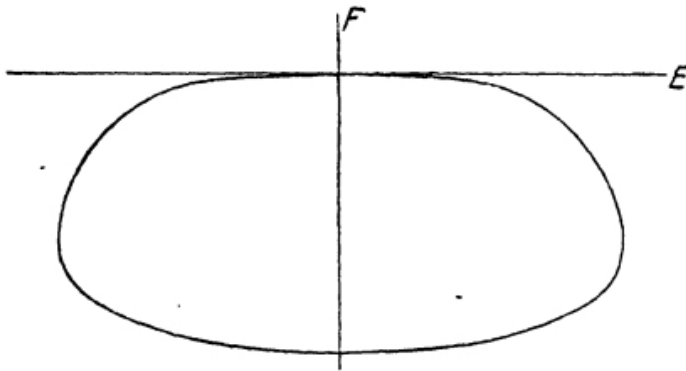

Fig. 5.

collision orbit in the E and F coordinates. We see that this orbit is perfectly regular in those coordinates, and so is the velocity of the orbit (see [38], p.63). There are no direct periodic orbits around L_2 .

II. Retrograde periodic orbits (Libration) around \mathcal{L}_3 (Class b).

These orbits are the symmetric counterparts – with respect to the η axis – of the orbits of class a. There are no direct periodic orbit around \mathcal{L}_3 .

III. Retrograde periodic orbits (Libration) around \mathcal{L}_1 (class c)

The existence of infinitely small retrograde periodic orbits around \mathcal{L}_1 was shown theoretically a while ago (Lyapunov family at \mathcal{L}_1). We see how the class evolves in Table 2. Figure 1 shows the shape of the infinitesimal librations (ellipses). Figure 2 shows a periodic orbit computed using numerical integration. Figure 3 shows a double collision (with m_1 and m_2) orbit. Figure 4 shows the subsequent formation of loops. Figure 5 shows the collision of the loops into the two finite masses, after which the creation of loops keeps happening until infinity. The amplitude of the family of orbits increases to infinity as the developments unveil. Therefore we have a class which starts at the libration point \mathcal{L}_1 and goes to infinity (see general proposition and [19, 20]). There are no direct periodic orbit around \mathcal{L}_1 .

IV. Periodic orbits (Libration) around \mathcal{L}_4 (class d).

For the chosen mass ratio ($m_1 = m_2$) our research didn't find any infinitesimal periodic orbit around \mathcal{L}_4 or \mathcal{L}_5 . For the problem with other masses, we refer to the paragraph VII.

V. Periodic orbits (Libration) around \mathcal{L}_5 (class e).

See the class of orbit d above.

VI. Retrograde periodic orbits around both finite masses with direct movement in the fixed system of coordinates (class l).

M. Moulton was the first to mention the existence of two groups of orbits revolving around both masses with retrograde motion in the rotating frame: one with direct motion in the fixed frame, one with retrograde motion. This happens when a quasi circular motion with big radius is considered. Then μ move slowly around the primary bodies m_1, m_2 .

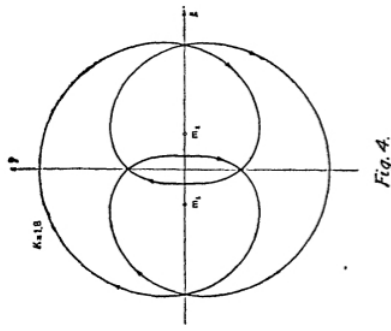

Fig. 4.

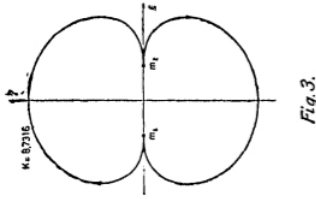

Fig. 3.

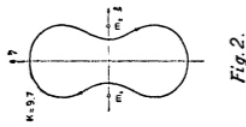

Fig. 2.

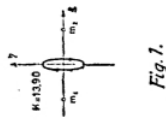

Fig. 1.

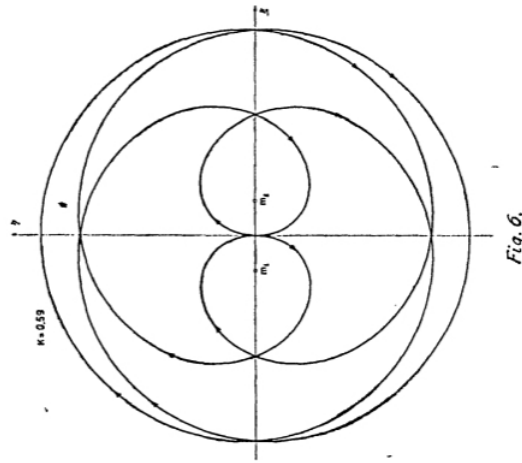

Fig. 6.

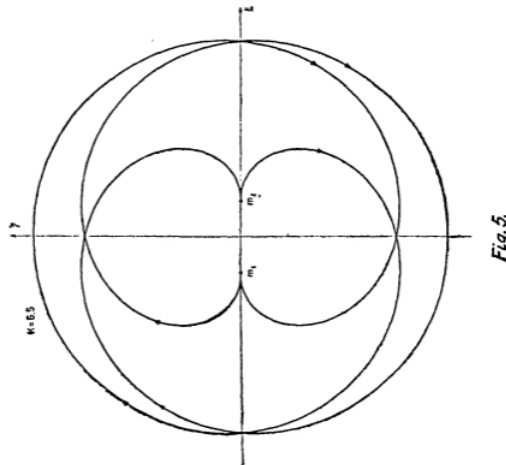

Fig. 5.

TABLEAU II.

The fixed movement can go either way in the fixed frame but both become retrograde in the rotating frame, since the system itself is subject to a strong direct movement. The initial discovery of the group with direct absolute movement arose from figure 6 and the curve shrinks around m_1, m_2 until it develops an indentation, then spikes, followed by loops on the η axis.

Figure 7 shows an enlargement of when the loops appear. An extended computation (figures 8 and 9 have a smaller scale) provides indentation at the bottom of the loop, exactly as the orbit itself makes a loop (figure 6). This leads us to think that the future evolution is as in figure 10-13: the indentation becomes a spike pointing up, the spike becomes a loop with upside indentation, then one down, then a loop, and so on with always decreasing scale. If we delete, to obtain a clear picture, the half where the arrow goes away from \mathcal{L}_4 , we can predict the resulting picture: a spiraling movement

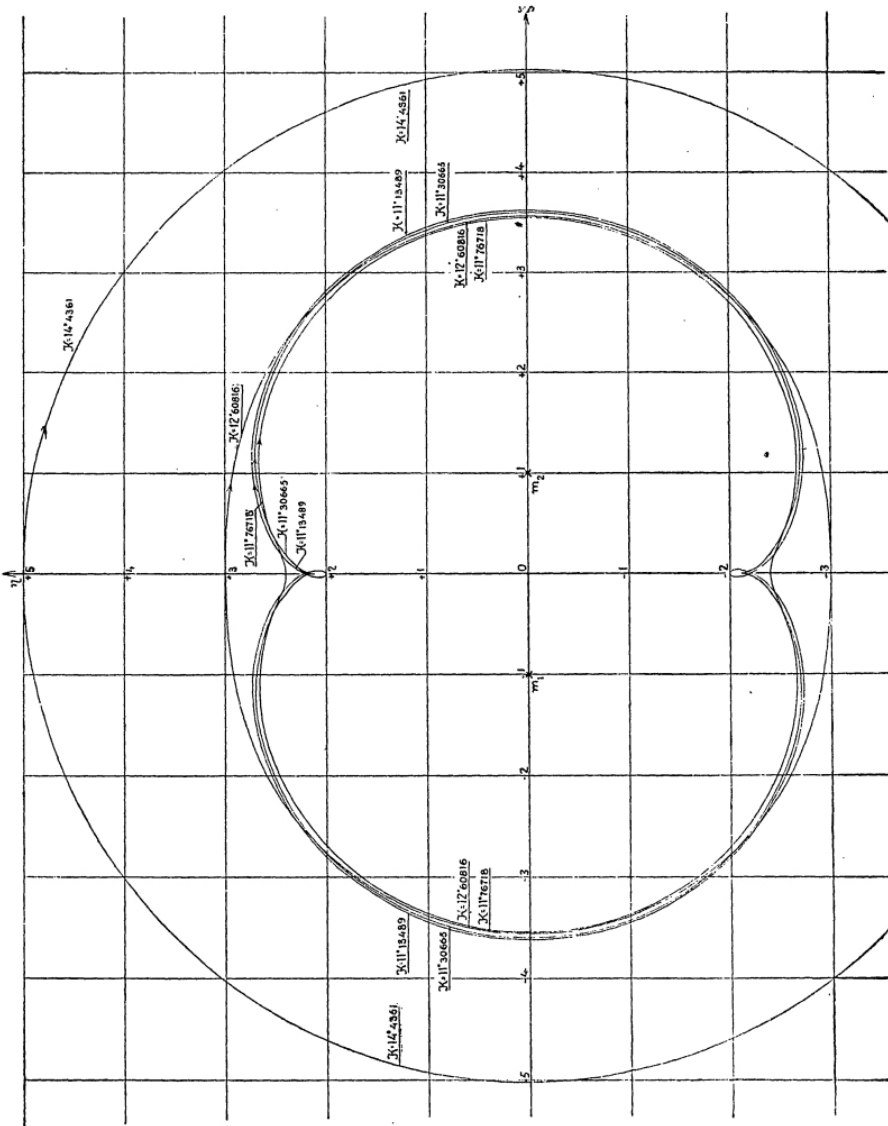

Fig. 6.

to the point \mathcal{L}_4 with decreasing amplitude and converging to zero speed. In other words, an asymptotic motion to \mathcal{L}_4 , the approach having infinite duration (a heteroclinic connection). The branch of motion omitted in figure 14 gives a corresponding asymptotic motion from the libration point to the outside. Comparing these results to figure 6 leads us to believe that the class of periodic orbits starts at infinity and ends at the libration points \mathcal{L}_4 and \mathcal{L}_5 . We also refer to [13, 38, 39, 40].

We remark that the theory of orbits spiraling to \mathcal{L}_4 and \mathcal{L}_5 has already been developed. In "*Astronomische Nachrichten*", the author published research (see [31]) resolving the problem. These research were followed by a sequence of essays which resulted in the following families.

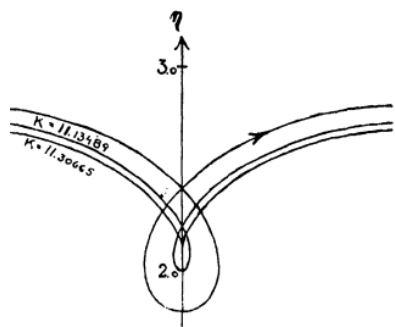

Fig. 7.

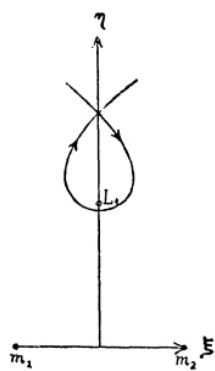

Fig. 8.

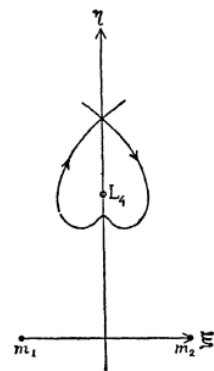

Fig. 9.

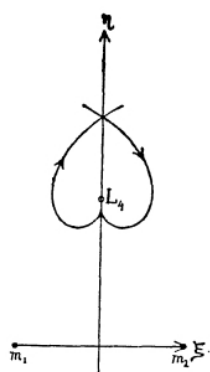

Fig. 10.

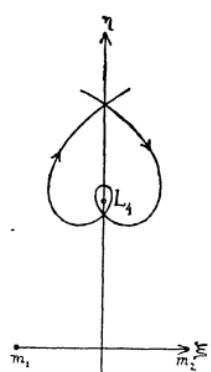

Fig. 11.

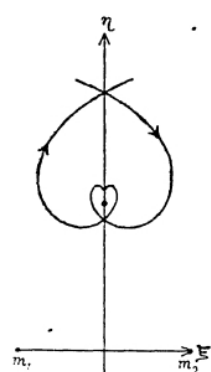

Fig. 12.

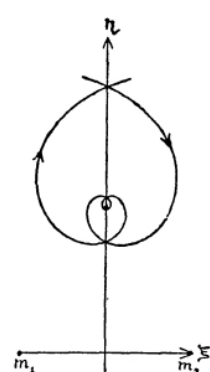

Fig. 13.

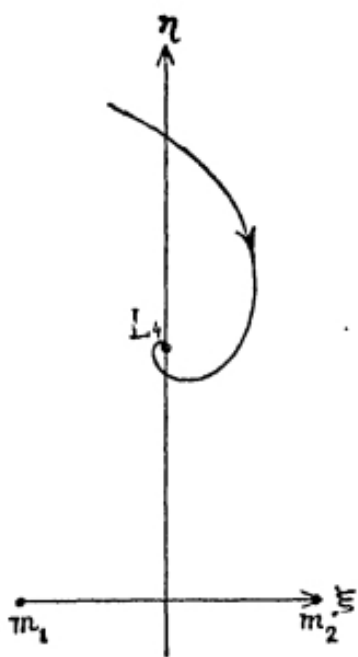

Fig. 14.

VII. Orbits approaching \mathcal{L}_4 and \mathcal{L}_5 asymptotically.

The system of equations we study has the center of mass at the origin. If one moves the origin to the libration point \mathcal{L}_4 using the transformation

$$\xi = x, \quad \eta = y + \sqrt{3}, \quad (9)$$

it follows, using (3), that

$$\begin{cases} \ddot{x} - 2\dot{y} = x - 4\left(\frac{x+1}{\rho_1^3} + \frac{x-1}{\rho_2^3}\right), \\ \ddot{y} + 2\dot{x} = y + \sqrt{3} - 4\left(\frac{y+\sqrt{3}}{\rho_1^3} + \frac{y+\sqrt{3}}{\rho_2^3}\right), \\ \rho_1^2 = (x+1)^2 + (y+\sqrt{3})^2, \\ \rho_2^2 = (x-1)^2 + (y+\sqrt{3})^2, \end{cases} \quad (10)$$

then we obtain the equations of motion for an infinitesimal mass with origin at \mathcal{L}_4 .

If we consider x and y so small that the higher powers of those terms can be neglected, we obtain the equations

$$\begin{cases} \rho_1^{-3} = \frac{1}{8} \left(1 - \frac{3}{4}(x + y\sqrt{3})\right), \\ \rho_2^{-3} = \frac{1}{8} \left(1 + \frac{3}{4}(x - y\sqrt{3})\right), \end{cases} \quad (11)$$

which we substitute into the differential equations (10), and after reduction we obtain

$$\begin{cases} \ddot{x} - 2\dot{y} = \frac{3}{4}x, \\ \ddot{y} + 2\dot{x} = \frac{9}{4}y, \end{cases} \quad (12)$$

These are the differential equations describing the infinitesimal motion of μ around \mathcal{L}_4 . Solving this system shows that, close to \mathcal{L}_4 , there are no periodic motions for μ , but only asymptotic solutions (see for example [47]).

Close to \mathcal{L}_4 , the coordinates x and y are expressed by

$$e^{-at} \sin(bt), \quad \text{and} \quad e^{-at} \cos(bt)$$

for the motion to \mathcal{L}_4 and

$$e^{at} \sin(bt), \quad \text{and} \quad e^{at} \cos(bt)$$

for the opposite motion.

By considering higher powers of x and y than in (10) we obtain a power series. We use these series to follow the motion of a mass further from \mathcal{L}_4 , but for big distances the work quickly becomes insuperable.

In our research on asymptotic motions starting or finishing at the libration we combined the process just mentioned with numerical integration starting really close to the libration point. We refer to [39, 42]. Using this approach, we looked at asymptotic orbits for \mathcal{L}_4 , the search for \mathcal{L}_5 being obtained by symmetry.

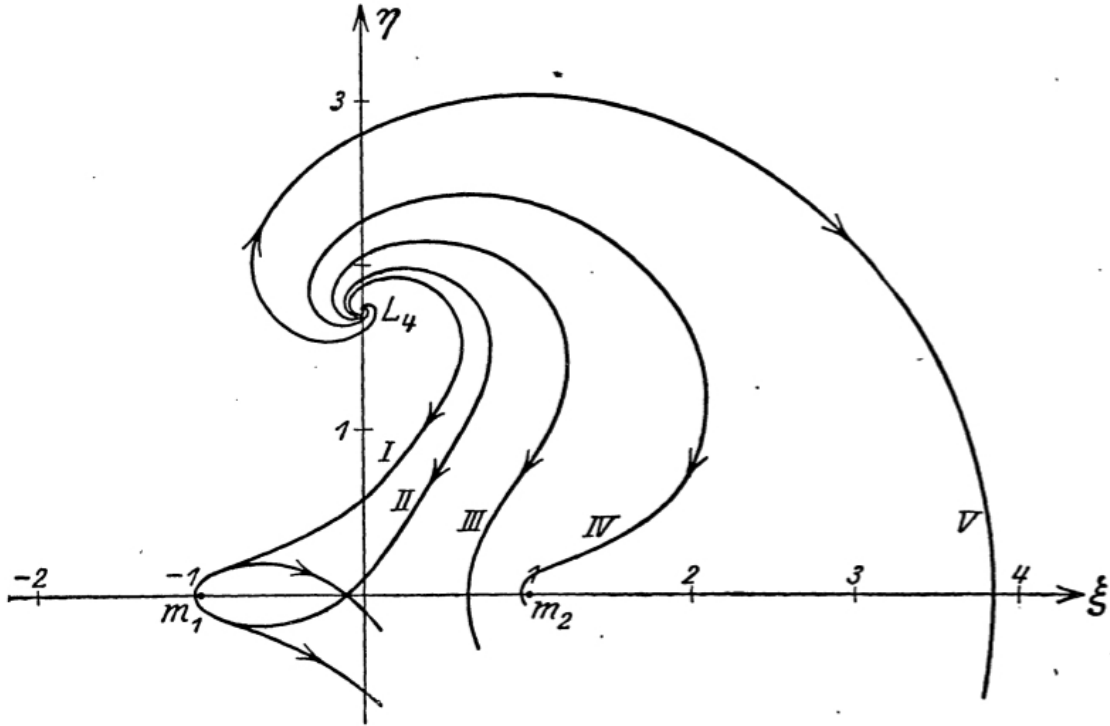

Fig. 15.

Table VI shows the results from the first stage of our computations – for asymptotic motions leaving \mathcal{L}_4 . Two of the main results can be expressed as follow:

1. There exist infinitely many asymptotic motion approaching/leaving \mathcal{L}_4 . (*translator's note: here he is describing the local stable/unstable manifolds.*)
2. If we specifically search for asymptotic motion cutting the ξ axis with a 90 degree angle after one quadrant of rotation, we find five orbits of this kind. They are showed in figure 15. Only one quadrant is displayed. We extend those orbits until they reach \mathcal{L}_5 using symmetries to complete the picture.

The five simple periodic orbits we found are labeled I, II, III, IV, V in figure 15 (see [39]). We note that the orbit V is identical to the limit orbit mentioned at pages 103-104 (*Translator's note: this is the numbering from the original paper. It is referring to the class from paragraph VI*), from the family of retrograde periodic orbits around the two masses with direct motion in the fixed coordinates (see [38, 39]). We will later discuss the meaning of the orbits I, II, III, IV .

These orbits are symmetric with respect to both axes, but there also exists a group of asymptotic orbits that are not symmetric to the axis η . We will investigate those later.

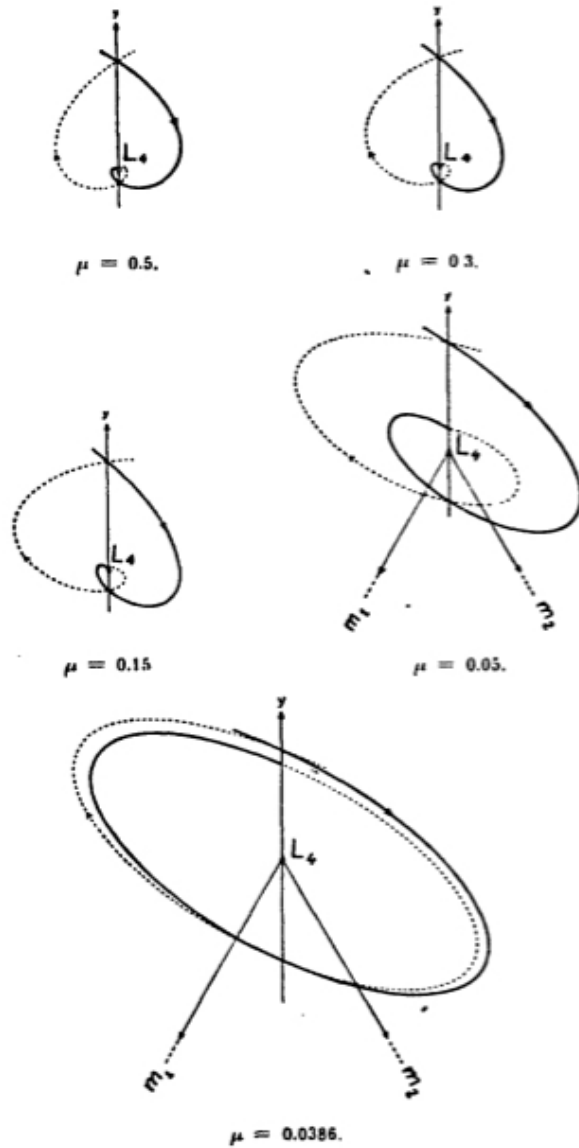

Fig. 16.

In our problem, with $m_1 = m_2$, we have no periodic solutions around \mathcal{L}_4 and \mathcal{L}_5 . We know that in general there are mass ratios $m_1 \neq m_2$ which admit infinitesimal periodic solutions around \mathcal{L}_4 and \mathcal{L}_5 . Indeed, one mass must be smaller than approximately $\frac{1}{25}$ the other (*Translator's note: This is referred to as the Routh criterion.*). Figure 16 illustrates the bifurcation from only asymptotic solutions to the existence of periodic solutions as the mass ratio crosses this value. On this figure μ represents the ratio $\frac{m_1}{m_1+m_2}$. In the Copenhagen problem μ is equal to 0.5. The critical value of μ for which periodic orbits appear is $\mu_0 = 0.038520896\dots$. In figure 16 the dotted lines represent the orbits leaving the libration point and the full lines are approaching.

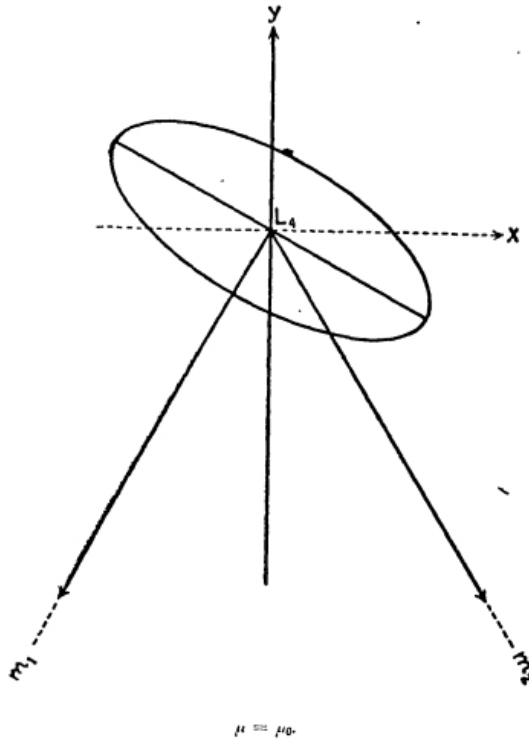

Fig. 17.

We illustrate the evolution of both branches for decreasing values of μ , until they approximatively meet at an ellipse for $\mu = 0.0386$. Figure 17 shows the value $\mu = \mu_0$ at which the ellipses appear for the first time (see [52]).

VIII. Retrograde periodic orbits around both masses, with retrograde motion in fixed coordinates (class m).

We follow this class up to infinity by shrinking the orbits around $m_1 m_2$ exactly as for the orbit class l . One sees in figure 18 and 19 (figure 19 has a much bigger scale than 18) that the orbits flatten as we approach m_1 and m_2 . At the same time, the velocity of the orbit increases. The mass moving along the smaller orbit in figure 19 passes near the primaries m_1 and m_2 : the velocity is high along the whole orbit but naturally even higher near the masses. The limit orbit is a straight motion between m_1 and m_2 with infinite velocity at each point. We thus find a class of orbit starting at infinity and ending in an orbit with collisions to m_1 in forward time and m_2 in backward time (see [17]).

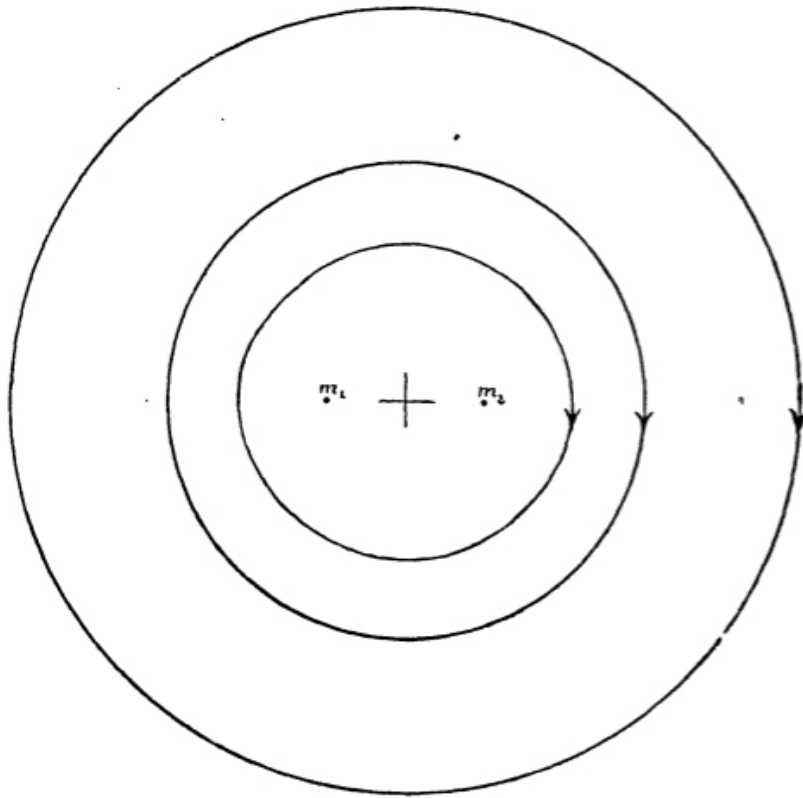

Fig. 18.

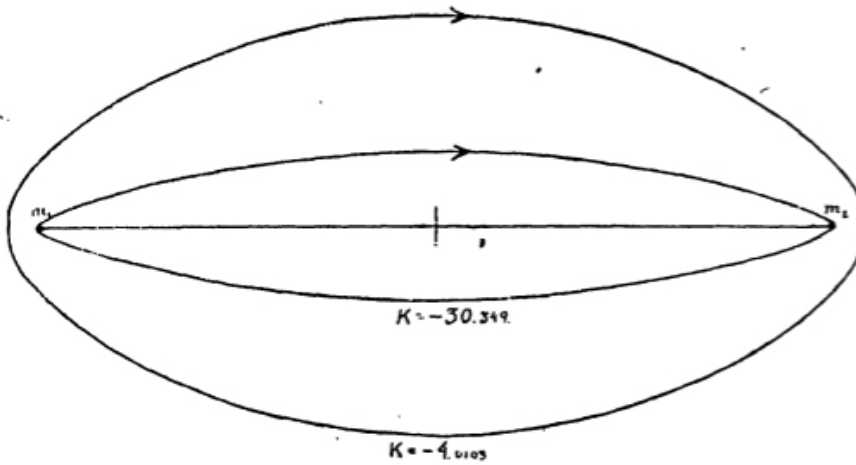

Fig. 19.

IX. Direct periodic orbits around both masses (orbit k).

We see in figure 20 a double collision orbit. Starting from this one in two opposite directions we find two ordered classes represented in figure 21 and 22. In depth research shows that both classes end in orbits asymptotically approaching \mathcal{L}_4 and \mathcal{L}_5 . We see that

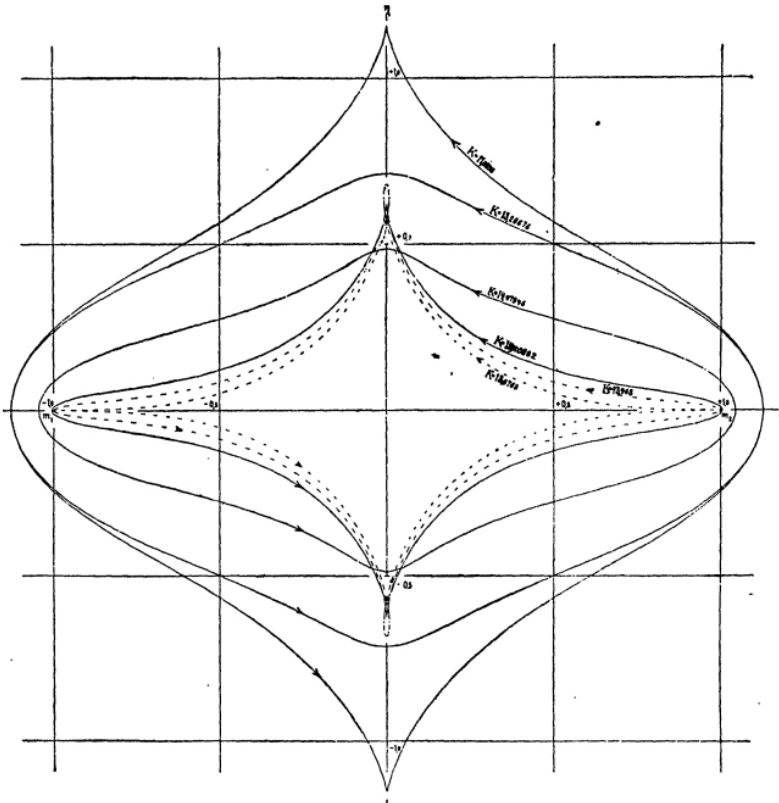

Fig. 20.

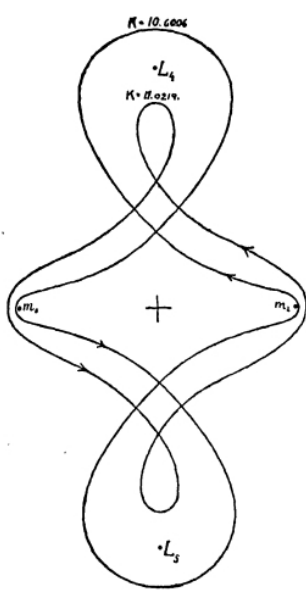

Fig. 21.

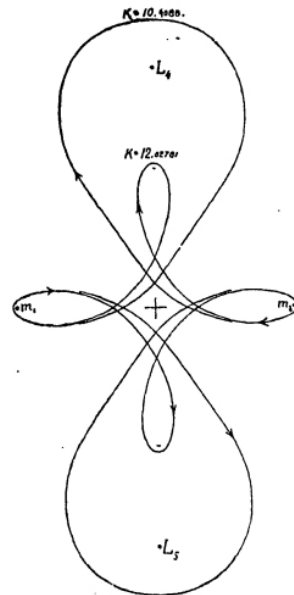

Fig. 22.

the two asymptotic orbits are identical to the asymptotic-periodic orbits given by *I* and *II* in Figure 15 (see [16, 49]). Thus, we have here a class of orbits whose limit orbits are both asymptotic.



TABLEAU III.

X. Retrograde periodic orbits around m_2 (class f).

Table III describes the discovery of this class: first small orbits around m_2 in figure 1 (circular motion infinitely close to m_2), then orbits with indentation close to m_1 (figure 2), followed by a collision with m_1 (figure 3) and orbits with loop around m_1 (figure 4). The loop approaches m_2 as the orbit increases (figure 5), and after this there follows a collision with m_2 (figure 6). The class keeps expanding with repetition of loops and collisions until infinity. Thus we have a class starting at one mass and ending at infinity (see [20]).

XI. Retrograde periodic orbits around m_1 (class h).

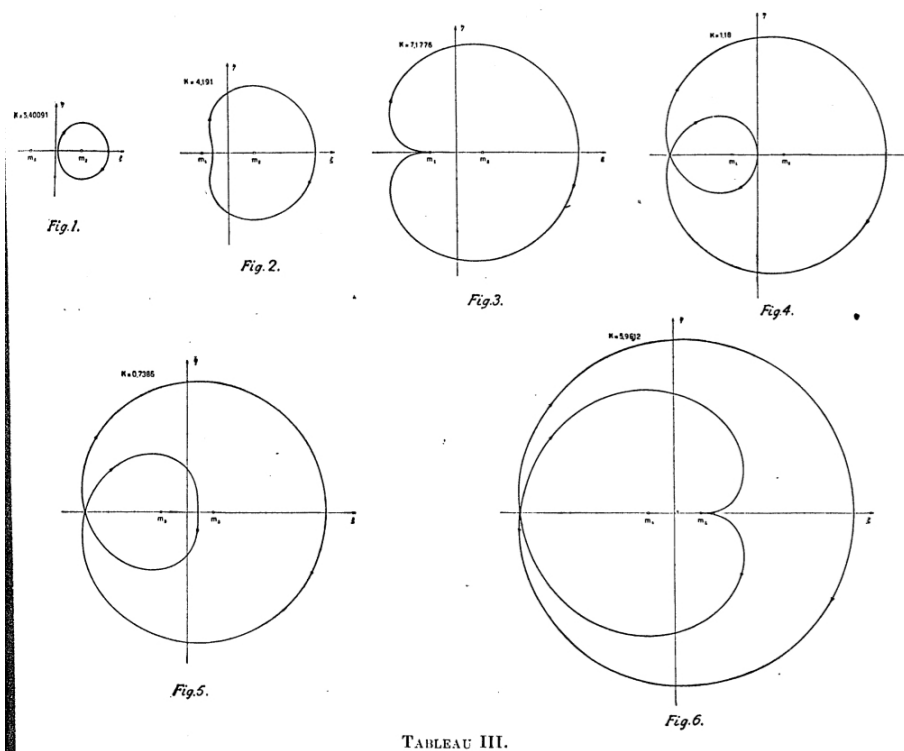
The evolution is the same as for the previous class f .

XII. Direct periodic orbits around m_2 (class g).

Figure 23 shows the birth of this class. Initially with infinitesimal circular orbits around m_2 , then oval orbits around the same mass, and finally a collision with m_2 . A great deal of work has been done to follow the class beyond this point (see figure 9–22 at page 16-21 of [37]). This work is not yet completed but it is sure that, one way or another, this class connects to the libration points \mathcal{L}_4 and \mathcal{L}_5 .

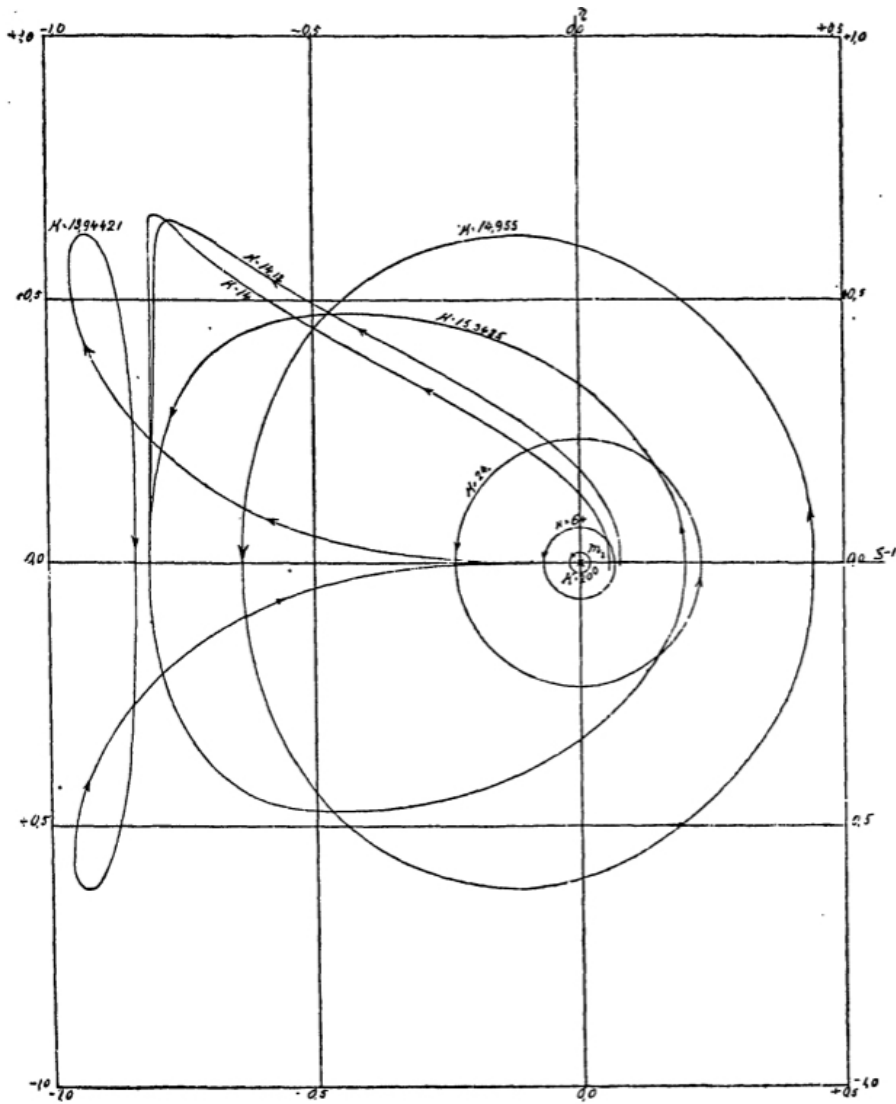

Fig. 23.

In "Periodic Orbits", Darwin devoted most of his attention to this class. A comparison between figure 23 of this work and the one from Darwin (figure 2 and 3 of Table IV in Periodic Orbits) shows an excellent fit despite the different choices of mass (Darwin used $m_1 = 10m_2$).

XIII. Direct periodic orbits around m_1 (class i).

They are similar to those in previous class g .



TABLEAU IV.

XIV. A class of retrograde periodic orbits entering itself and not symmetric with respect to η (class n).

A common characteristic to all the previous classes is that their existence results from a systematic search to find periodic orbits

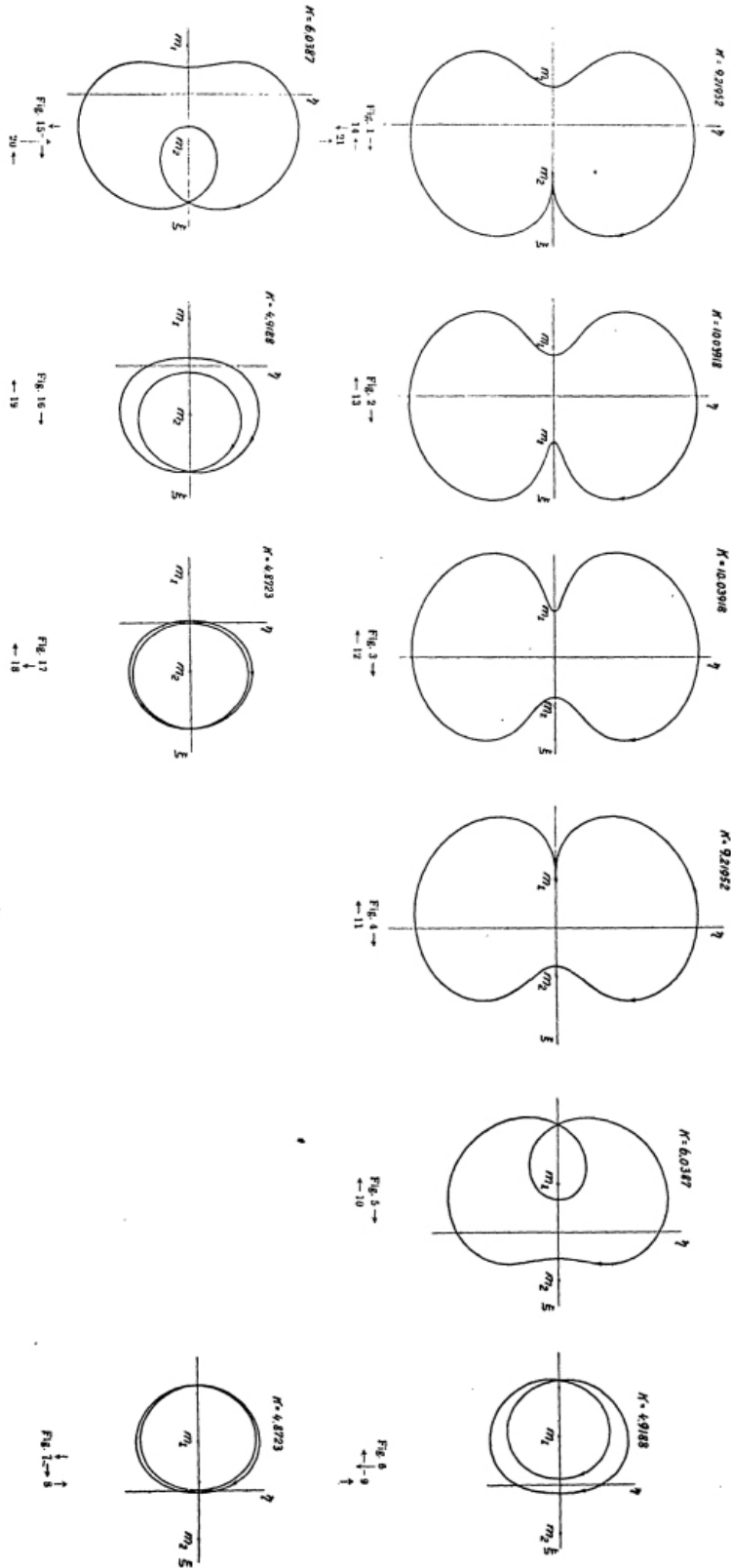
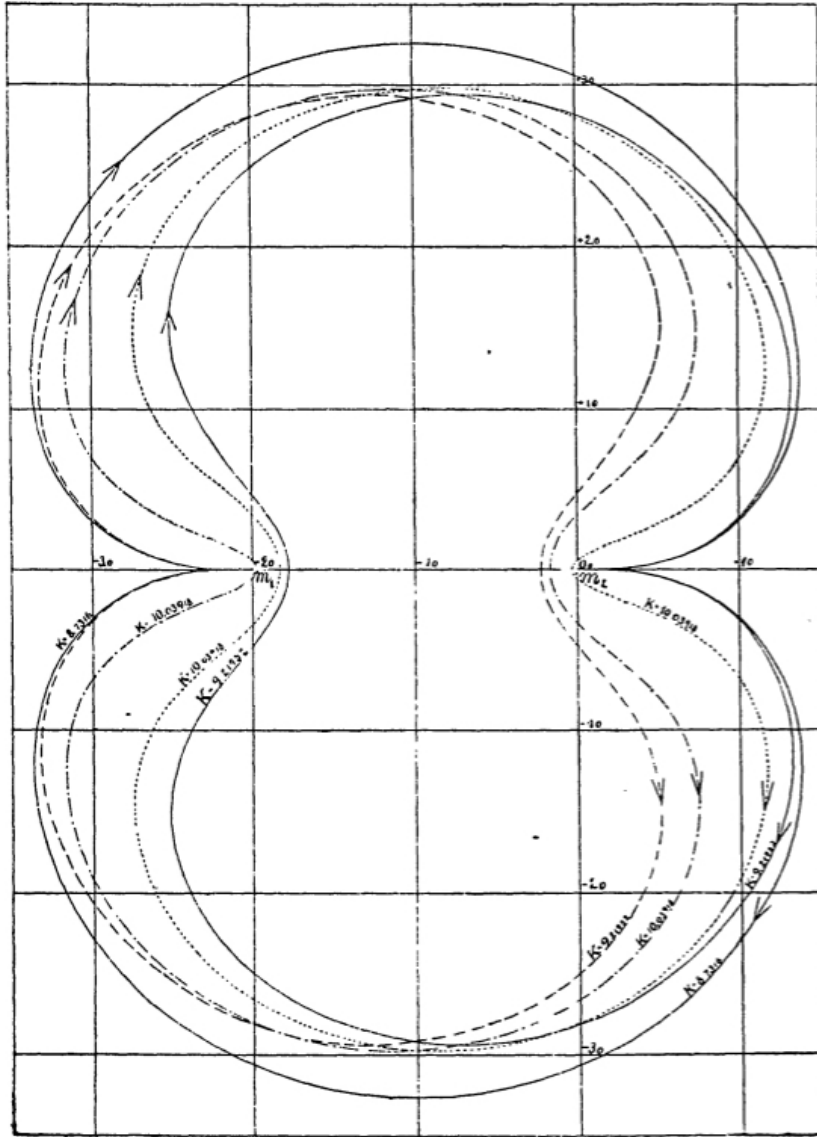

Fig. 24.

whose existence was predictable. This is not the case for this class which was found, by pure chance, while working on other classes of orbits. Figure 24 and Table IV show the unexpected and interesting development of this class, which made us give up our original principle. That is, to stop the analysis of a class once it reaches a collision, when a motion with a complicated nature was reached. We have at figure 24 (except for the curve sketched entirely which is identical to the double collision orbit in class *c*) a sequence of libration looking orbits, which starts by a backward time collision at m_2 and finishes with a collision with m_1 (in the middle, we obviously get to an orbit symmetric with respect to the η axis; this orbit is actually identical to one of the librations in class *c*).

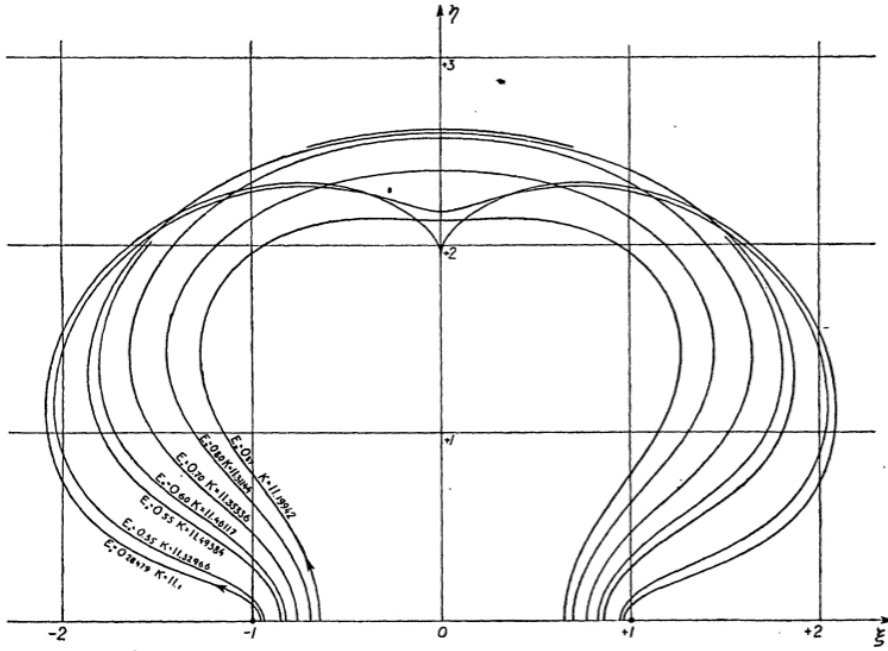

Fig. 25.

Starting from the collision orbit at m_1 we obtain orbits with loops around m_1 ; the evolution of these orbits is presented in Table IV (figure 1 – 21). The loop gets bigger as the orbit itself shrinks. This continues until the loop and the orbit overlap, and if we continue, the loop becomes the orbit and reversely. That is, we obtain the same evolution but in reverse.

Once beyond the collision with m_1 we continue to the collision with m_2 . Then follow loops around m_2 , identical to the previous ones around m_1 , and they evolve in the same way until we get back to the beginning: the collision with m_2 . Therefore we have a class of orbits entering itself (see [28]). To see the Fourier expansion for the coordinates of these orbits, we refer to [37], page 25.

XV. A class of retrograde orbits, libration looking, symmetric with respect to η , with two asymptotic orbits as limit orbits (class r).

Figure 25 shows seven orbits belonging to this class. Note that this class admits the two asymptotic orbits *III* and *IV* in figure 15 as limits. To make the connection obvious we draw both orbits in figure 26. The orbit corresponding to $K = 11.1$ in figure 25 is very close to the limit orbit *IV*, while the orbit for $K = 11.19942$ is close to *III*. Thus one can follow the transition from one limit to another in figure 25. Therefore, we have again a class of periodic orbits caught between two asymptotic orbits (see [19, 29]).

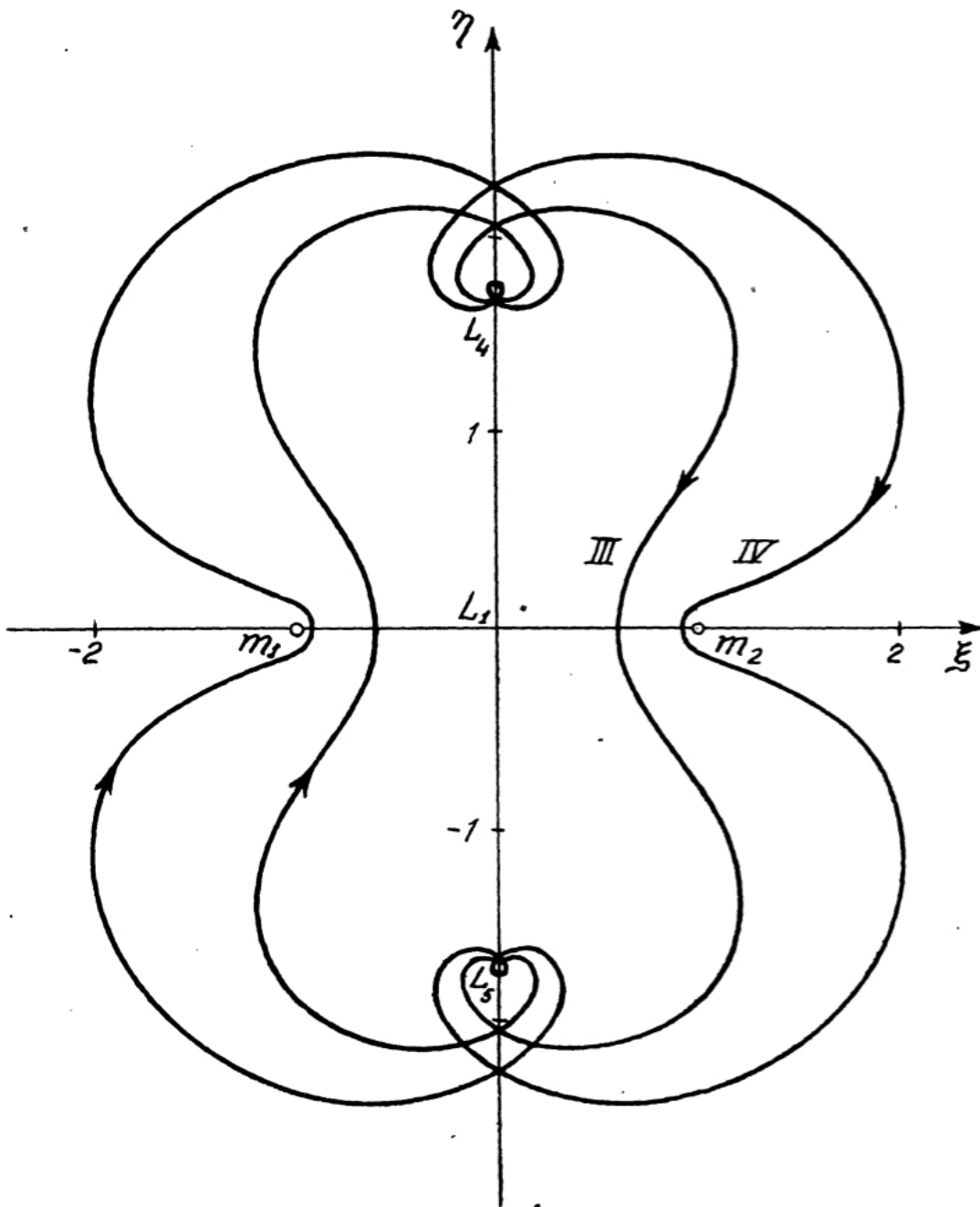

Fig. 26.

XVI. A class of retrograde orbits, libration looking, asymmetric with respect to η , with two asymptotic orbits as limit orbits (class o).

Figure 27 shows six orbits (three orbits and their symmetric counterparts) belonging to this class. The beginning and end of this class are interesting. One of the limit orbits of the class is, indeed, a combination of the left half of the asymptotic orbit *III* previously

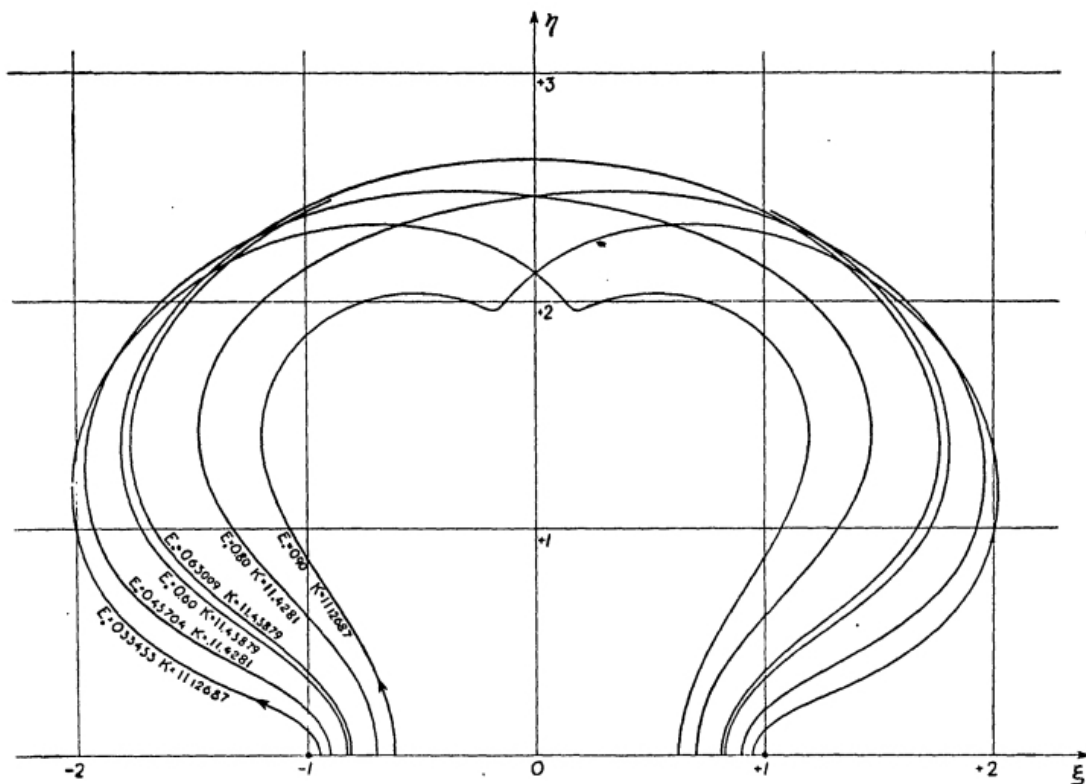

Fig. 27.

mentioned and the right half of *IV* (figure 28). Similarly, the other limit orbit (figure 29) is the combination of the left side of *IV* with the right side of *III*. We, then again, have a class of periodic orbits with two asymptotic orbits as limits (see [19, 29]).

XVII. Other classes of periodic orbits with two asymptotic limit orbits (class *s*).

This last class admits limit orbits made of pieces of the asymptotic orbits *III* and *IV*. Thus one constructs all the possible combinations with the five asymptotic orbits *I, II, III, IV, V* (in figure 15). We obtain nine new asymptotic orbits, with no symmetry (therefore ten in total and twenty including symmetric counterparts) which open a broad new perspective since there is no doubt that all those orbits should be limits of classes of asymmetric orbits. These classes however are so melted with each other that their numerical determination would require a considerable amount of work.

From a methodological point of view we have here a whole new problem. The five double symmetric orbits mentioned in **VII** (figure 15) were all classified as limits of classes already known from previous work. In these cases the problem was to first look at a representative of the class to then find its limits.

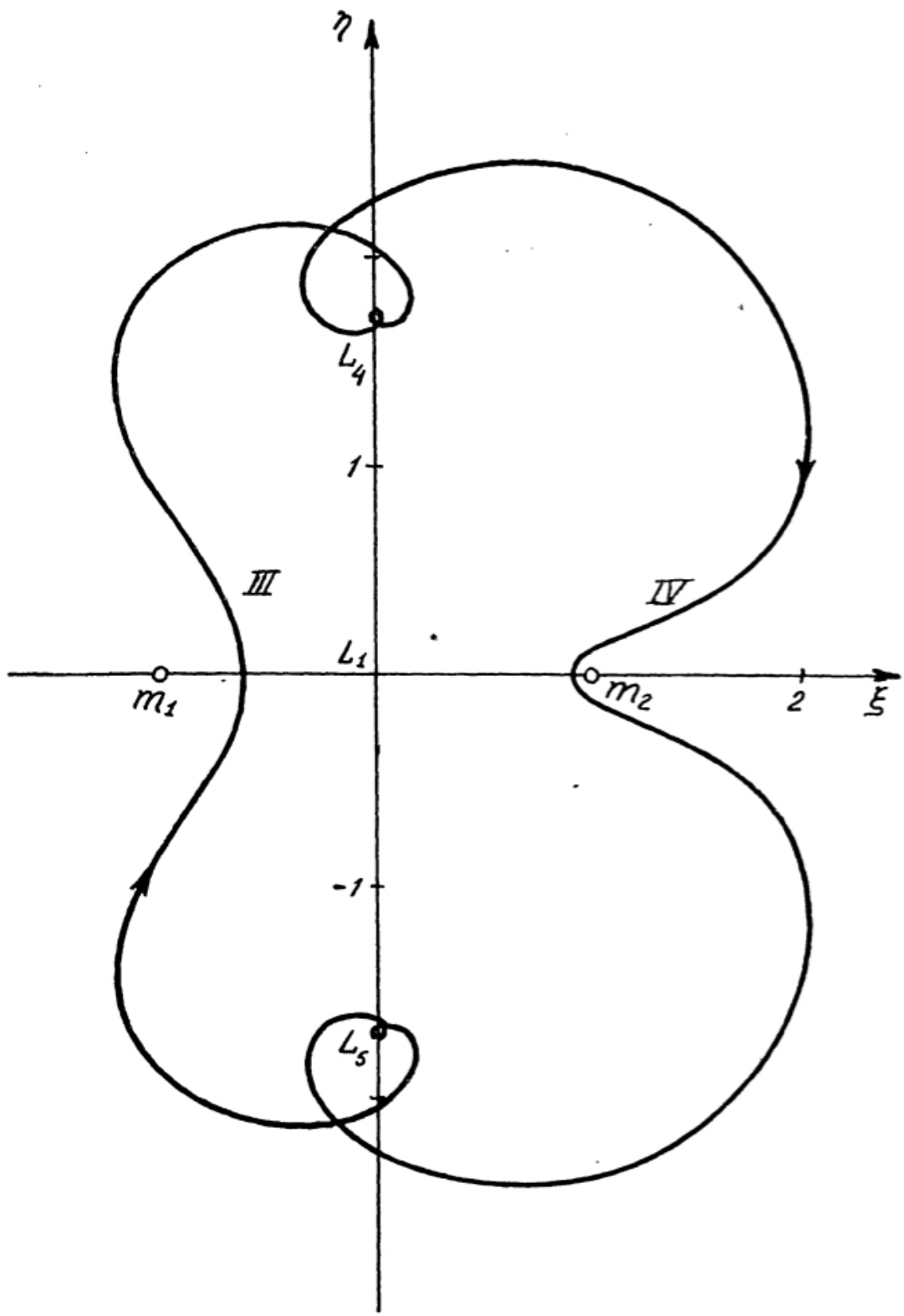

Fig. 28.

The problem is now the opposite: we have a number of asymptotic orbits which we predict with confidence are limits of periodic

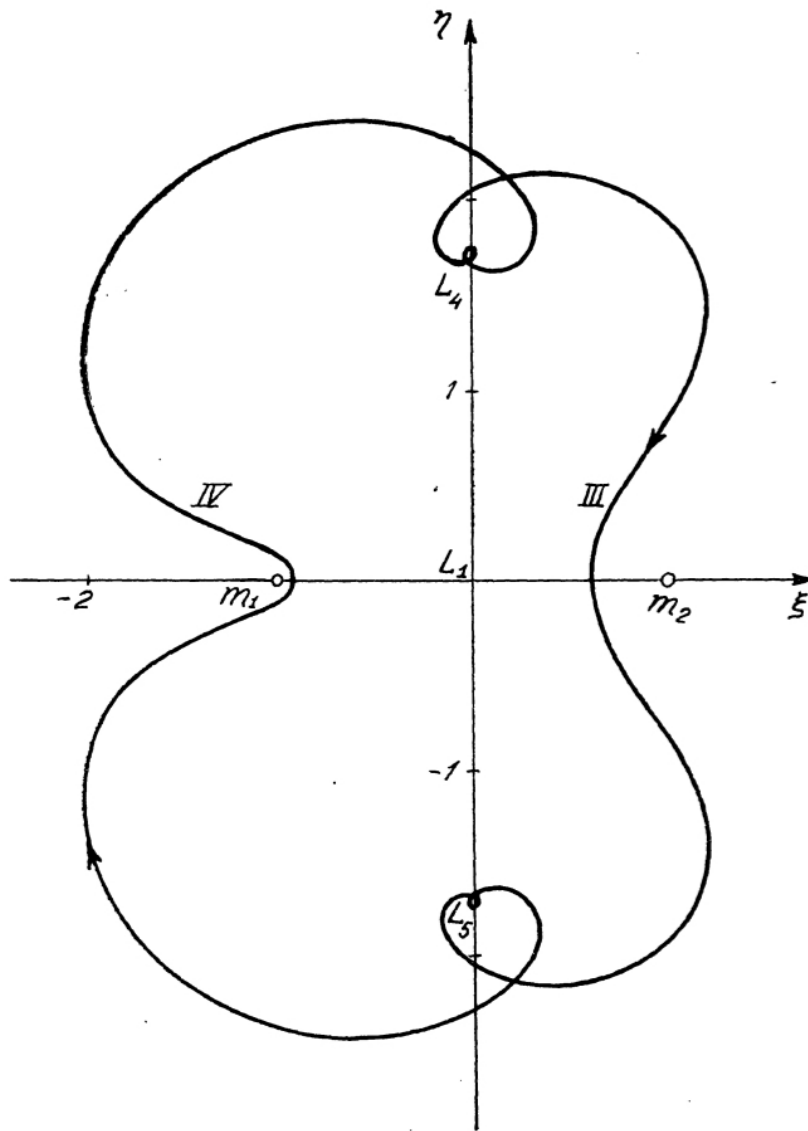
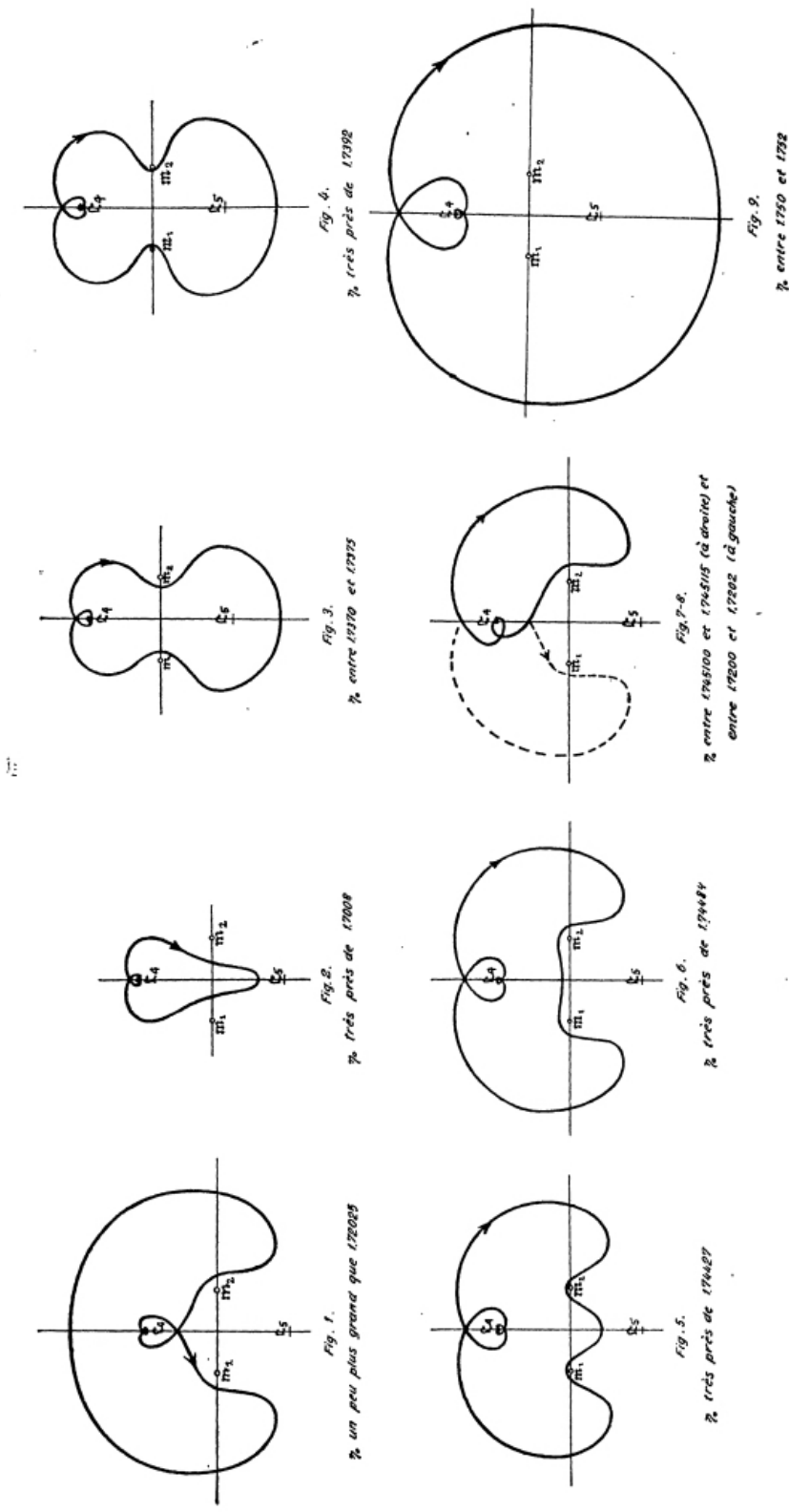

Fig. 29.

classes, and we now seek to reconstruct the one from the another. We encounter a similar problem in XVIII (see [29]).

XVIII. Simple periodic orbits, asymptotic to \mathcal{L}_4 and \mathcal{L}_5 and asymmetric with respect to ξ .

In this paragraph we also consider a number of class whose limit orbits are asymptotic. At page 106 the existence of simple periodic orbits, asymptotic to \mathcal{L}_4 and \mathcal{L}_5 and asymmetric with respect to ξ was mentioned. This problem was discovered when considering the same problem but with symmetry. Many orbits asymptotic to \mathcal{L}_4 were followed until they met η after half a rotation. We determined that when they cut the axis with a right angle they become symmetric to their first part and therefore are asymptotic



TABEAU V.

to \mathcal{L}_4 again (the analogous case with \mathcal{L}_5 exists as well). According to the experiments there was no doubt that these new asymptotic

orbits where limit orbits of some periodic class.

Table *VII* shows the new set of asymptotic orbits and table *V* reproduces the asymptotic orbits meeting the η axis with a right angle and as described. The problem of combining parts of these orbits has been studied and essentially solved. See figure 9 of Table *V* and its symmetric counterpart with respect to ξ . Together these form the limits of a class of periodic orbits. It is reasonable to think the same for the pair in figures 3 and 4 as well as for the pair in figures 7 and 8. It is also very likely that figure 1 must be combined with figure 6, and figure 2 with figure 5 (see [44, 47]).

The five asymptotic orbits mentioned in **VII** are the only existing simple asymptotic orbits which are also symmetric with respect to η and asymmetric with respect to ξ . In table *VII* one sees the existence of asymptotic orbits which are periodic after more than one revolution, for example:

1. An orbit at $1.700 < \eta_0 < 1.7015$ which will cut the ξ axis (going up) for the second time (to the left of the η axis) with a right angle;
2. An orbit at $1.719 < \eta_0 < 1.720$ analogous to 1;
3. An orbit at $1.742 < \eta_0 < 1.743$ which will cut the ξ axis with a right angle but at its fourth crossing;
4. An orbit with η_0 slightly bigger than 1.7452 analogous to 1;
5. An orbit with η_0 slightly bigger than 1.752 analogous to 1;

There are countless such orbit, but since they are not simple periodic, that is periodic after one revolution, they are out of the considered program at Copenhagen observatory. The possible simple periodic orbits, asymptotic to \mathcal{L}_4 (or \mathcal{L}_5) were all covered by **VII** and **XVIII**.

XIX. Asymptotic orbit to the libration points $\mathcal{L}_1, \mathcal{L}_2$ and \mathcal{L}_3 .

The asymptotic orbits to \mathcal{L}_1 , \mathcal{L}_2 and \mathcal{L}_3 can be periodic only for special values of the mass ratio. For the mass ratio used in our research ($m_1 = m_2$) there are no such periodic orbits. Asymptotic orbits get closer to or move away from \mathcal{L}_1 , \mathcal{L}_2 or \mathcal{L}_3 without spiraling. Instead of exponential and trigonometric expressions as encountered before (see **VII**), we obtain here purely exponential terms.

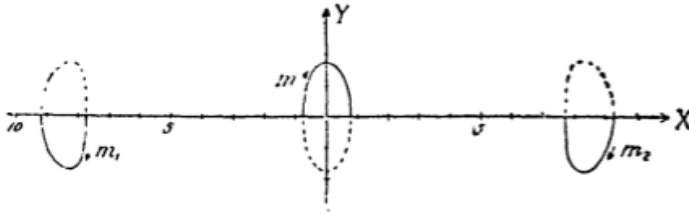

Fig. 30.

XX. More general gravitational problems. Cases of the three body problem and one with additional bodies.

In a text from 1900 (see [30]) the author started numerical computations for the case where all three masses had the same order of magnitude. It was the first time that the approach of numerical integration was applied to such problem. The work was continued in 1909 and at the same time that research on the restricted problem began in Copenhagen. The goal was to find, if possible, periodic orbits. A solution, displayed in figure 30, was finally found in 1919 with the case of the mass ratio $m_1 : m : m_2$ equal to $1 : 2 : 1$.

Using a rotating frame we realized that this problem is simply an extension to the finite domain of infinitesimal periodic orbits that we already know and which correspond to the infinitesimal libration around \mathcal{L}_1 , \mathcal{L}_2 and \mathcal{L}_3 in the restricted problem (Table II and figure 3). Extended research showed that the orbits continue to collisions between m_1 and m (or m_2 and m). Figure 31 shows the motion in a system close to collision. We also computed a "libration" case for four equal masses, see figure 32 and [36, 40]. We remark that research into the problem with three or four equal masses of the same order of magnitude provides an opportunity to generalize results from the restricted problem of three bodies.

5 Acknowledgment

Fifty seven collaborators successively took part to the numerical research on the three body problem done at Copenhagen observatory. The organization was mostly done by J. Fischer-Petersen and Jens P. Möller. I would like to thank the "fonds de Carlsberg" for the support they provided.

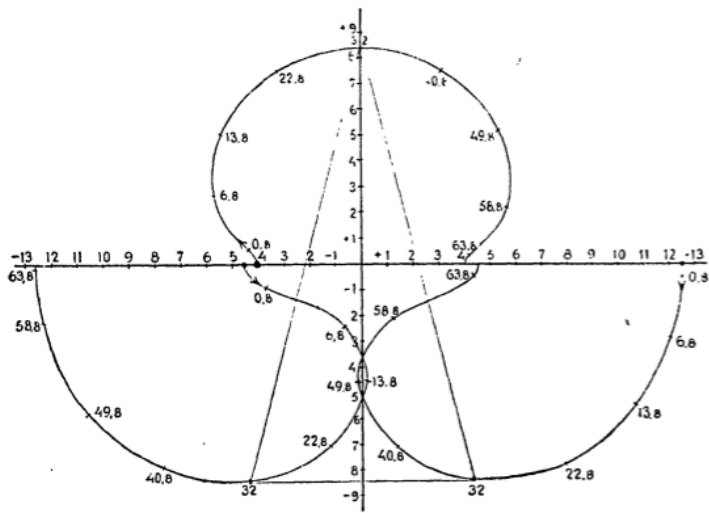

Fig. 31.

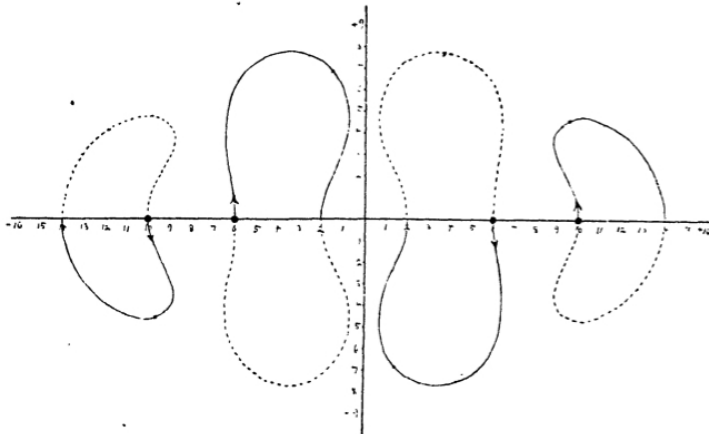

Fig. 32.

6 Conclusion

The main tool for our research is the simple technique of numerical integration. Among the mathematical concepts which played an important role we mention the transformation of the differential equation, from the work of Thiele, as well as (to start the computation in some cases) the infinitesimal solution of those equations.

It is of great interest to mention where our research increased our knowledge beyond the results of Poincaré on the restricted problem. Here are the two main things.

1. With our choice of finite masses it is no longer a perturbation problem where the solution can be established using power series and small quantities.
2. Our research had a broader goal than just finding periodic and

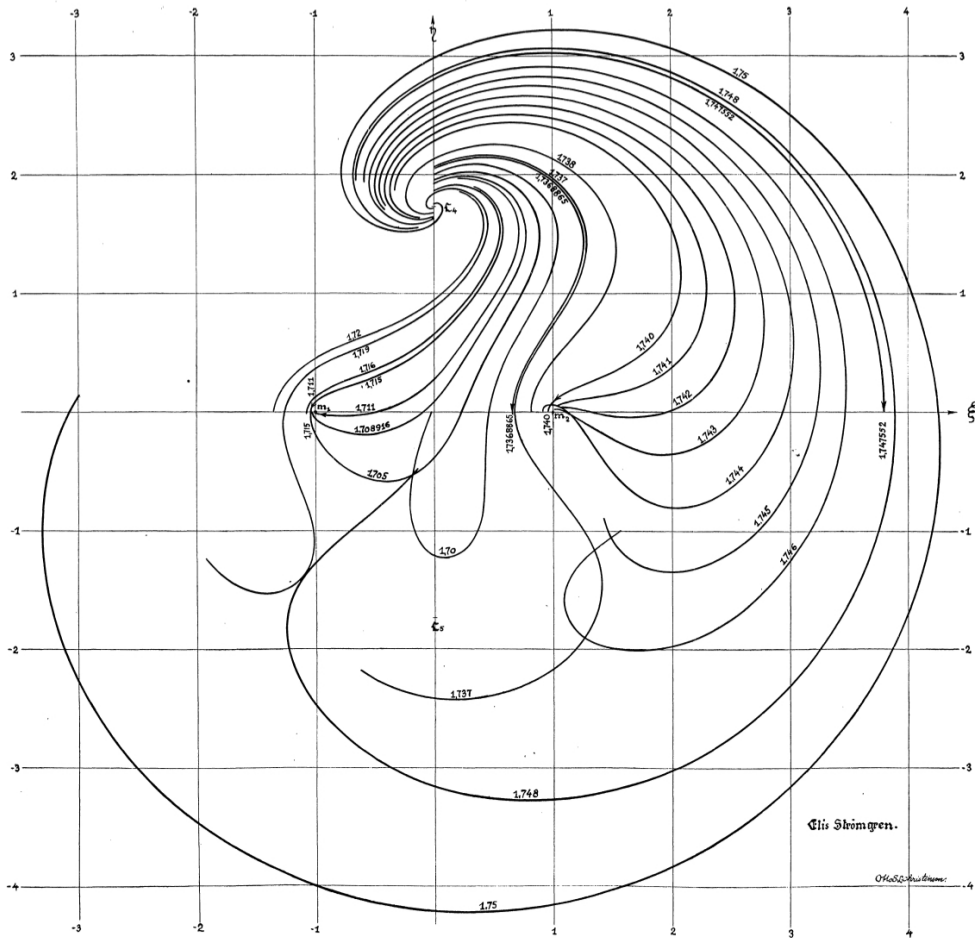

TABLÉAU VI.

asymptotic solutions near some initial conditions found using analytics approach. The goal was to systematically follow classes from a natural starting point until a natural ending.

We listed in the Introduction, the different possibilities for the start and end of classes. We would have reached the optimal target in the three body problem in the case where we would have established general formulas for the motion of this celestial problem: Formulas which allow one to compute the motion at any time by substituting different values of time into them. It is toward this goal that so many mathematicians and astronomers put their effort since the discovery of the law of gravitation.

It seems the problem was solved 25 years ago when M. Sundman published a few essays where he establish mathematical formulas for the motion in the three body problem using power series which converge (in the mathematical sense) for all values of time.

We never doubted his results, but a detailed execution was missing: that is, an explicit computation. For this reason we were un-

sure of the applicability of series to practical goals. We were also working with conditions which would probably make the convergence of Sundman's series too slow to be applicable in practice.

Recently M. Belorizky showed in "Recherches sur l'application pratique des solutions générales du problème des trois corps" that the convergence of Sundman's series is actually so slow that they would never be applicable in practice. Sundman mentioned himself, at the 1930 reunion of "Astronomische Gesellschaft" in Budapest, that research involving numerical integration are now the only applicable way to solve the three body problem.

In this work, we presented a summary of the results obtained by numerical integration regarding simple periodic or asymptotic motion in the restricted problem; this summary provides a map for a scientific domain which was *terra incognita* a few decades ago. It is my hope that the cartography presented here will be a basis for a mathematical exposition of the problem.

References

- [1] C. Burrau. Recherches numériques concernant des solutions périodiques d'un cas spécial du problème des trois corps. *Astronomische Nachrichten*, 3230, 1894.
- [2] C. Burrau. Recherches numériques concernant des solutions périodiques d'un cas spécial du problème des trois corps (deuxième mémoire). *Astronomische Nachrichten*, 3251, 1894.
- [3] C. Burrau. Numerische berechnung eines spezialfalles des dreikörperproblem. publ. de l'observatoire de copenhague 13. *Astronomische Nachrichten*, 4662, 1913.
- [4] C. Burrau and E. Strömngren. Ueber librationen und ejektionsbahnen. publ. cop. 18. *Astronomische Nachrichten*, 4721, 1913.
- [5] C. Burrau and E. Strömngren. Numerische untersuchungen über eine klasse periodischer bahnen im problème restreint. publ. cop. 21. *Astronomische Nachrichten*, 4795, 1915.
- [6] C. Burrau and E. Strömngren. Numerische untersuchungen über eine klasse einfach periodischer, retrograder bahnen im problème restreint, nebst der diese klasse abschliessenden, periodischen ejektionsbahn (masseverhältnis $m_1 = m_2$). publ. cop. 22. *Astronomische Nachrichten*, 4836, 1916.
- [7] C. Burrau and E. Strömngren. Ueber ein system von ejektionsbahnen im problème restreint. publ. cop. 24. *Astronomische Nachrichten*, 4842, 1916.

- [8] C. Burrau and E. Strömngren. Ueber eine klasse periodischer bahnen um die beiden endlichen massen im problème restreint. publ. cop. 26. *Astronomische Nachrichten*, 4865, 1916.
- [9] J Fischer-Petersen. Ueber unendlich kleine periodische bahnen um die massenpunkte im problè restreint. publ. cop. 22. *Astronomische Nachrichten*, 4799, 1915.
- [10] J. Fischer-Petersen. Ueber unendlich kleine retrograde, periodische bahnen um die massenpunkte im problème restreint. publ. cop. 23. *Astronomische Nachrichten*, 4837, 1916.
- [11] J. Fischer-Petersen. Die auf der kopenhagener sternwarte ausgeführten numerischen untersuchungen über das dreikörperproblem. publ. cop. 27. *Sirius*, 10-11, 1917.
- [12] J. Fischer-Petersen and E. Strömngren. Ueber eine neue art librationen im problème restreint. publ. cop. 26. *Astronomische Nachrichten*, 4872, 1916.
- [13] J. Fischer-Petersen and E. Strömngren. Ueber eine klasse einfach periodischer, retrograder bahnen um die beiden endlichen massen im problème restreint. publ. cop. 30. *Astronomische Nachrichten*, 4968, 1918.
- [14] K. Kristiansson. Untersuchung einer klasse in bezug auf die ξ -achse unsymmetrischer, periodischer bahnen um beide massen im problème restreint. publ. cop. 89. *Astronomische Nachrichten*, 5991, 1933.
- [15] M. Lindow. Ein nomogramm zur thieleschen transformation. publ. cop. 40. *Astronomische Nachrichten*, 5128, 1921.
- [16] K. Lous. A certain class of periodic orbits around the two finite masses in the restricted problem of three bodies . publ. cop. 32. *Astronomische Nachrichten*, 5008, 1919.
- [17] J.P. Möller. Die einfach periodischen retrograden bahnen um die beiden massen im problème restreint, mit retrograder absoluter bewegung. publ. cop. 48. *Astronomische Nachrichten*, 5286, 1924.
- [18] J.P. Möller. Drei bahnklassen im problème restreint. *V. J. S. der A. G.*, 1926.
- [19] J.P. Möller. Vier bahnklassen im problème restreint. publ. cop. 60. *Astronomische Nachrichten*, 5571, 1928.
- [20] J.P. Möller. Zwei bahnklassen im problème restreint. publ. cop. 99. *Académie Danoise*, XIII, 5, 1935.

- [21] P. Pedersen. Fourier series for the periodic orbits around the triangular libration points. publ. cop. 101. *M. N. of the R. A. S.*, 95, 5, 1935.
- [22] P. Petersen. periodische bahnen in grosser entfernung von den beiden endlichen massen im problème restreint. publ. cop. 30. *Astronomische Nachrichten*, 4968, 1918.
- [23] P. Petersen. Die erweiterung der lagrangeschen dreieckstösungen im allgemeinen dreikörperproblem. publ. cop. 35. *Astronomische Nachrichten*, 5013, 1920.
- [24] P. Petersen. On the periodic orbits in the neighbourhood of the triangular equilibrium points in the restricted problem of three bodies. publ. cop. 91. *M. N. of the R. A. S.*, 94,2, 1933.
- [25] J. Rosenthal. The equation of stability of periodic orbits of the restricted problem of the three bodies in thiele's regularising coordinates. publ. cop. 78. *American Journal of Mathematics*, 53, 3, 1931.
- [26] H. Samter. Ueber eine gruppe von bahnen im problème restreint. publ. cop. 44. *Astronomische Nachrichten*, 5267, 1924.
- [27] H. Samter. Ueber eine klasse von bahnen im problème restreint. publ. cop. 45. *Astronomische Nachrichten*, 5276, 1924.
- [28] E. Strömngren. Ueber mechanische integration und deren verwendung für numerische rechnungen auf dem gebiete des dreikörperproblem. *Publ. de l'observatoire de Lund*, 13, 1900.
- [29] E. Strömngren. Ein asymptotischer fall im dreikörperproblem. *Astronomische Nachrichten*, 4015, 1905.
- [30] E. Strömngren. Ueber spitzen und schleifen im problème restreint. *Astronomische Nachrichten*, 4155, 1906.
- [31] E. Strömngren. Ein numerisch gerchneter spezialfall des dreikörperproblem mit massen und distanzen von derselben grössenordnung. *Astronomische Nachrichten*, 4356, 1909.
- [32] E. Strömngren. Ueber librationen und ejektionsbahnen. publ. cop. 14. *Vierteljahrsschrift der Astr. Gesellschaft*, 48,3, 1913.
- [33] E. Strömngren. A new class of periodic solutions in the general problem of three bodies, viz. in the problem of three bodie with all masses and all distances of the same order of magnitude. publ. cop. 34. *M. N. of the R. A. S.*, 80(1), 1919.
- [34] E. Strömngren. Librationen und periodische ejektionsbahnen im allgemeinen dreikörperproblem. publ. cop. 38. *Astronomische Nachrichten*, Jubiläumsnummer, 1921.

- [35] E. Strömngren. Forms of periodic motion in the restricted problem and in the general problem of three bodies, according to researches at the observatory of Copenhagen. publ. cop. 39. *A lecture delivered at the interscandinavian congress of mathematicians, Helsingfors, 1922.*
- [36] E. Strömngren. Tre aartier celest mekanik paa köbenhavns observatorium. *Anniversaire de l'univ. de Copenhague, nov. 1923, 1923.*
- [37] E. Strömngren. Zur durchmusterung des problèmes restreint. publ. cop. 47. *Seeliger-Festschrift, 1924.*
- [38] E. Strömngren. Unsere kenntnisse über die bewegungsformen im dreikörperproblem. *Ergebnisse der exakten Naturwissenschaften, IV, 1925.*
- [39] E. Strömngren. Das system der periodischen und asymptotischen bahnen im problème restreint. *V. J. S. der A. G., 1926.*
- [40] E. Strömngren. Asymptotische lösungen im problème restreint. publ. cop. 61. *Académie Danoise, IX, 3, 1929.*
- [41] E. Strömngren. Fortsetzung und abschluss der librationen um \mathcal{L}_2 und \mathcal{L}_3 im problème restreint. publ. cop. 63. *Académie Danoise, IX, 6, 1929.*
- [42] E. Strömngren. Periodische bahnen um \mathcal{L}_4 (besw. \mathcal{L}_5) im problème restreint bei beliebigem verhältnis der zwei endlichen massen. publ. cop. 64. *Académie Danoise, IX, 7, 1929.*
- [43] E. Strömngren. Das kritische massenverhältnis bei der bewegung um \mathcal{L}_4 und \mathcal{L}_5 im problème restreint. publ. cop. 70. *Académie Danoise, X, 11, 1930.*
- [44] E. Strömngren. Die retrograden periodischen bahnen um die beiden enlichen massen im problème restreint, mit direkter absoluter bewegung (klasse l). publ. cop. 69. *Académie Danoise, X, 9, 1930.*
- [45] E. Strömngren. Fortgesetzte untersuchungen über asymptotische bahnen im problème restreint. publ. cop. 67. *Académie Danoise, X, 7, 1930.*
- [46] E. Strömngren. Ueber die kritische masse im problème restreint und über das problème restreint im allgemeinen. publ. cop. 72. *V. J. S. der A. G., 1930.*
- [47] E. Strömngren. Die direkten periodischen bahnen um beide massen im im problème restreint (klasse k). publ. cop. 80. *Académie Danoise, XI, 7, 1931.*

- [48] E. Strömghren. Eine klasse unsymmetrischer librationsähnlicher periodischer bahnen im problème restreint und ihre entwicklungsgeschichte (klasse n). publ. cop. 94. *Académie Danoise*, XII, 11, 1934.
- [49] E. Strömghren. Symmetrische und unsymmetrische librationsähnliche bahnen im problème restreint mit asymptotisch-periodischen bahnen als grenzbahnen. publ. cop. 97. *Académie Danoise*, XIII, 1, 1934.
- [50] T.N. Thiele. Recherches numériques concernant des solutions périodiques d'un cas spécial du problème des trois corps (troisième mémoire). *Astronomische Nachrichten*, 3289, 1895.
- [51] A. Wintner. Librationstheorie des restringierten dreikörperproblems. publ. cop. 71. *Math. Zeitschrift*, 32, 5, 1930.
- [52] A. Wintner. Beweis des e. strömghrenschen dynamischen abschlussprinzips der periodischen bahngruppen im restringierten dreikörperproblem. publ. cop. 75. *Math. Zeitschrift*, 31, 3, 1931.
- [53] A. Wintner. Sortengenealogie, hekubakomplex und gruppenfortsetzung. publ. cop. 79. *Math. Zeitschrift*, 34, 3, 1931.
- [54] A. Wintner. Three notes on characteristic exponents and equations of variation in celestial mechanics (i. upon the characteristic exponents of the celestial mechanics; ii. upon the characteristic exponents in the strömghrenian groups of periodic orbits; iii. upon the equation of jacobi for dynamical systems with two degrees of freedom). publ. cop. 78. *American Journal of Mathematics*, 53, 3, 1931.